

# CATÁLOGO 2023

i l u m i n a c i ó n l e d



**WINLED**  
Más que Iluminación

**artlite**  
ILUMINACIÓN LED



Duo Pack



## ALA-029

LÁMPARA LED SMART  
WIFI Y BLUETOOTH E26  
10W RGB CW MULTICOLOR  
Y BLANCOS ATENUABLES



Duo Pack



## ALA-030

LÁMPARA LED SMART  
WIFI Y BLUETOOTH GU10  
6W RGB CW MULTICOLOR  
Y BLANCOS ATENUABLES

BULBO	10 WATTS	MÁX. 850 LÚMENES
RGB CW MULTICOLOR Y BLANCOS ATENUABLES	110-130V~ 50/60Hz ENTRADA	E26 BASE
PROTECCIÓN IP20 INTERIOR	SI ATENUABLE	60x119 mm DIMENSIONES
OMNIDIRECCIONAL	180°	PLÁSTICO MATERIAL

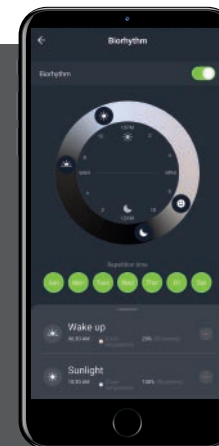
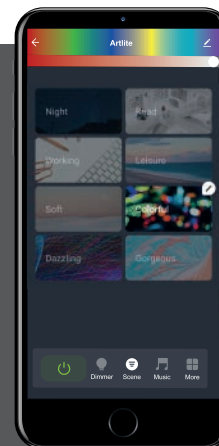
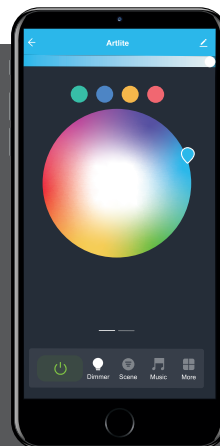
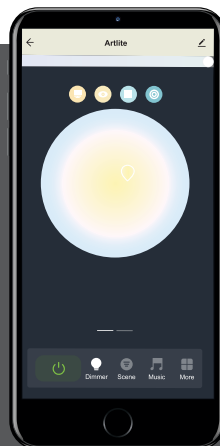

SPOT	6 WATTS	MÁX. 400 LÚMENES
RGB CW MULTICOLOR Y BLANCOS ATENUABLES	110-130V~ 50/60Hz ENTRADA	GU10 BASE
PROTECCIÓN IP20 INTERIOR	SI ATENUABLE	50x55 mm DIMENSIONES
DIRECCIONAL	105°	PLÁSTICO MATERIAL



Descarga App  
Smart Life



Regístrate



Agrega los productos



Controla

\*Incluye 1 controlador y 1 driver.

## ASM-001

TIRA LED SMART RGB CW  
COLORES Y BLANCOS  
DINAMICOS WIFI BLUETOOTH  
C/DRIVER



\*APP disponible para sistemas IOS y ANDROID.  
\*Requiere conexión a internet mediante red Wi-Fi 2.4 GHz.  
\*Compatible con comando de voz: Google Assistant y Amazon Alexa.

Conéctanos con:

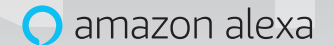

## ASM-002

ENCHUFE SMART REDONDO  
BLANCO WIFI BLUETOOTH  
MÁX. 1875W



24 WATTS

MÁX. 1,300 LÚMENES

RGB CW  
MULTICOLOR  
Y BLANCOS  
ATENUABLES

100-240V~  
50/60Hz  
ENTRADA

INCLUYE  
CONTROLADOR  
Y DRIVER

PROTECCIÓN  
IP65  
EXTERIOR

SI  
ATENUABLE

5000  
x  
12mm  
DIMENSIONES

OMNIDIRECCIONAL

120°

CUBIERTA  
DE SILICON  
MATERIAL

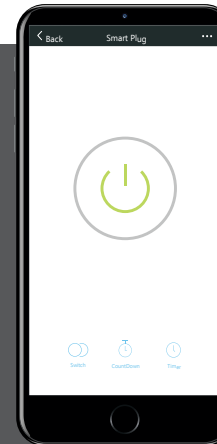
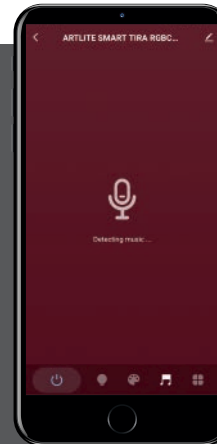
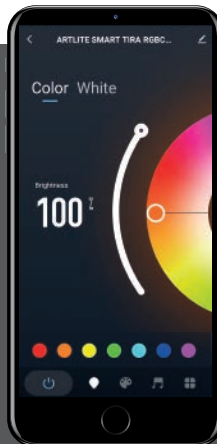

MÁX. 1875 WATTS

90-260V~  
50/60Hz  
ENTRADA

MÁXIMO 15A  
CORRIENTE  
@125V~

POLICAR-  
BONATO  
MATERIAL

50.6x52  
mm  
DIMENSIONES

PROTECCIÓN  
IP20  
INTERIOR

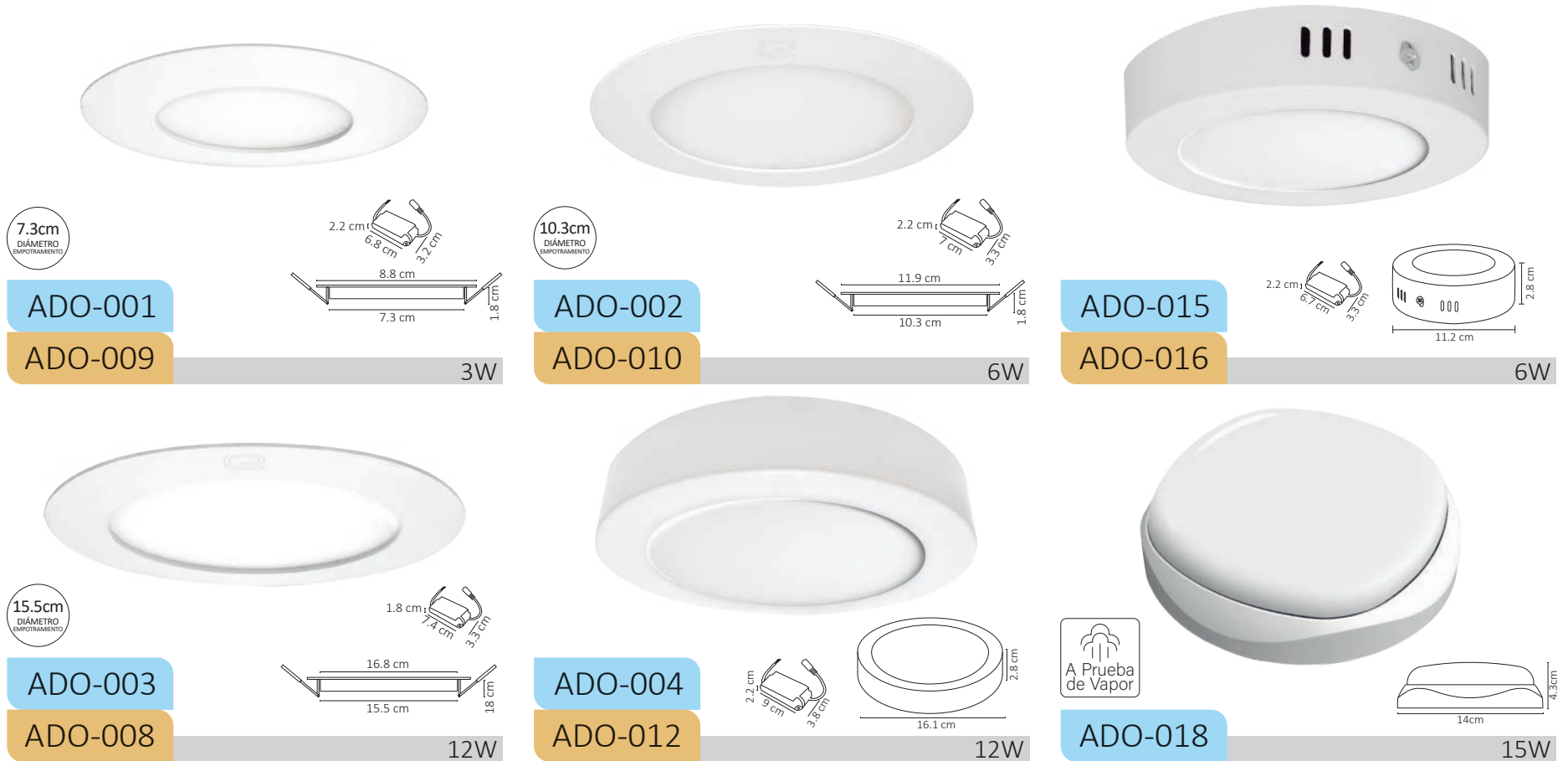

#	💡	Ⓜ	⚡	☀️	360°	🌈	↔️	💎	💧	🔍
Código	Producto	Watts	Voltaje	Lúmenes	Apertura	Temp. Color	Dimensiones	Material	Protección	Observaciones
ADO-001	Pánel LED Redondo Slim Blanco Frío	3W	90-277V~50/60Hz	250LM	120°	6500K	D. 88x18mm	Lámina + Policarbonato	IP20	Incluye Driver/Emp. 7.3cm
ADO-009	Pánel LED Redondo Slim Blanco Cálido	3W	90-277V~50/60Hz	230LM	120°	3000K	D. 88x18mm	Lámina + Policarbonato	IP20	Incluye Driver/Emp. 7.3cm
ADO-002	Pánel LED Redondo Slim Blanco Frío	6W	90-277V~50/60Hz	500LM	120°	6500K	D. 119x18mm	Lámina + Policarbonato	IP20	Incluye Driver/Emp. 10.3cm
ADO-010	Pánel LED Redondo Slim Blanco Cálido	6W	90-277V~50/60Hz	450LM	120°	3000K	D. 119x18mm	Lámina + Policarbonato	IP20	Incluye Driver/Emp. 10.3cm
ADO-015	Pánel LED Redondo Sobreponer Blanco Frío	6W	90-277V~50/60Hz	500LM	120°	6500K	D. 112x28mm	Lámina + Policarbonato	IP20	Incluye Driver
ADO-016	Pánel LED Redondo Sobreponer Blanco Cálido	6W	90-277V~50/60Hz	450LM	120°	3000K	D. 112x28mm	Lámina + Policarbonato	IP20	Incluye Driver
ADO-003	Pánel LED Redondo Slim Blanco Frío	12W	90-277V~50/60Hz	1,000LM	120°	6500K	D. 168x18mm	Lámina + Policarbonato	IP20	Incluye Driver/Emp. 15.5cm
ADO-008	Pánel LED Redondo Slim Blanco Cálido	12W	90-277V~50/60Hz	950LM	120°	3000K	D. 168x18mm	Lámina + Policarbonato	IP20	Incluye Driver/Emp. 15.5cm
ADO-004	Pánel LED Redondo Sobreponer Blanco Frío	12W	90-277V~50/60Hz	1,000LM	120°	6500K	D. 161x28mm	Lámina + Policarbonato	IP20	Incluye Driver
ADO-012	Pánel LED Redondo Sobreponer Blanco Cálido	12W	90-277V~50/60Hz	950LM	120°	3000K	D. 161x28mm	Lámina + Policarbonato	IP20	Incluye Driver
ADO-018	Pánel LED Redondo Sobreponer Blanco Frío	15W	100-277V~50/60Hz	1,400LM	120°	6500K	D. 140x43mm	Plástico + Policarbonato	IP65	Incluye Driver/A Prueba de Vapor





20.5cm  
DIÁMETRO  
EMPOTRAMENTO

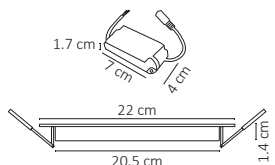

ADO-005

ADO-011

18W



ADO-013

ADO-014

18W

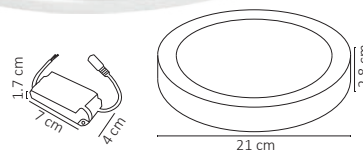

28cm  
DIÁMETRO  
EMPOTRAMENTO

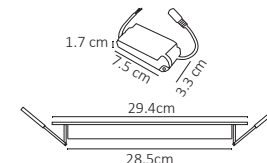

ADO-019

ADO-020

24W

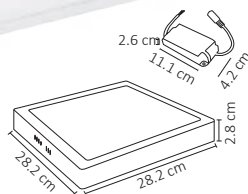

ADO-017

24W

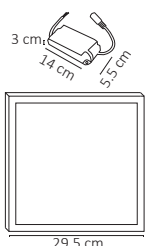

ADO-006

25W



ADO-007

40W

#	💡	Ⓜ	⚡	☀️	360°	🌈	📏	💎	💧	🔍
Código	Producto	Watts	Voltaje	Lúmenes	Apertura	Temp. Color	Dimensiones	Material	Protección	Observaciones
ADO-005	Pánel LED Redondo Slim Blanco Frío	18W	90-277V~50/60Hz	1,500LM	120°	6500K	D. 220x14mm	Lámina + Policarbonato	IP20	Incluye Driver/Emp. 20.5cm
ADO-011	Pánel LED Redondo Slim Blanco Cálido	18W	90-277V~50/60Hz	1,450LM	120°	3000K	D. 220x14mm	Lámina + Policarbonato	IP20	Incluye Driver/Emp. 20.5cm
ADO-013	Pánel LED Redondo Blanco Frío	18W	90-277V~50/60Hz	1,500LM	120°	6500K	D. 210x28mm	Lámina + Policarbonato	IP20	Incluye Driver
ADO-014	Pánel LED Redondo Blanco Cálido	18W	90-277V~50/60Hz	1,450LM	120°	3000K	D. 210x28mm	Lámina + Policarbonato	IP20	Incluye Driver
ADO-019	Pánel LED Redondo Slim Blanco Frío	24W	90-277V~50/60Hz	2,000LM	120°	6500K	D. 294x18mm	Lámina + Policarbonato	IP20	Incluye Driver/Emp. 28.5cm
ADO-020	Pánel LED Redondo Slim Blanco Cálido	24W	90-277V~50/60Hz	1,950LM	120°	3000K	D. 294x18mm	Lámina + Policarbonato	IP20	Incluye Driver/Emp. 28.5cm
ADO-017	Pánel LED Cuadrado Sobreponer Blanco Frío	24W	90-277V~50/60Hz	1,800LM	120°	6500K	282x282x28mm	Lámina + Policarbonato	IP20	Incluye Driver
ADO-006	Pánel LED Cuadrado Slim Blanco Frío 30cm	25W	90-277V~50/60Hz	2,000LM	120°	6500K	295x295x25mm	Aluminio + Policarbonato	IP20	Incluye Driver y Sujetadores
ADO-007	Pánel LED Cuadrado Slim Blanco Frío 60cm	40W	90-277V~50/60Hz	3,400LM	120°	6500K	595x595x25mm	Aluminio + Policarbonato	IP20	Incluye Driver y Sujetadores

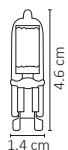

ALA-026



2W

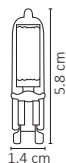

ALA-027



4W

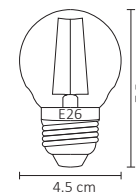

ALA-023



2W

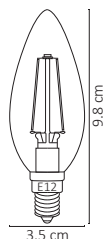

ALA-005



4W

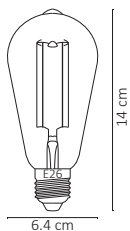

ALA-022



4W

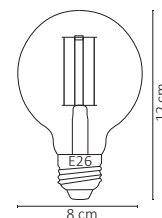
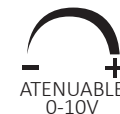

ALA-028



7W

#	💡	Ⓜ	⚡	☀️	360°	🌈	📏	💎	💧	🔍
Código	Producto	Watts	Voltaje	Lúmenes	Apertura	Temp. Color	Dimensiones	Material	Protección	Observaciones
ALA-026	Lámpara LED G9 2W Ambar	2W	100-140V~50/60Hz	150LM	320°	1800K	D. 14x50mm	Vidrio	IP20	G9
ALA-027	Lámpara LED G9 4W Ambar	4W	100-140V~50/60Hz	300LM	320°	1800K	D. 15x60mm	Vidrio	IP20	G9
ALA-023	Lámpara LED Filamento E26 2W G45 Ambar	2W	100-140V~50/60Hz	180LM	320°	1800K	D. 45x75mm	Lámina + Vidrio	IP20	E26
ALA-005	Lámpara Vela E12 Filamento Blanco Cálido	4W	100-140V~50/60Hz	400LM	320°	2700K	D. 35x98mm	Lámina + Vidrio	IP20	E12 - Dimeable
ALA-022	Lámpara LED Filamento E26 4W ST64 Ambar	4W	100-140V~50/60Hz	360LM	320°	1800K	D. 64x140mm	Lámina + Vidrio	IP20	E26 - Dimeable
ALA-028	Lámpara LED de Filamento E26 7W Ambar	7W	100-140V~50/60Hz	700LM	320°	1800K	D. 80x120mm	Lámina + Vidrio	IP20	E26 - Dimeable

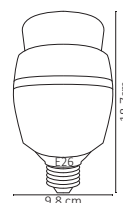
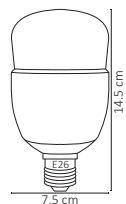

ALA-019

30W

ALA-016

100W

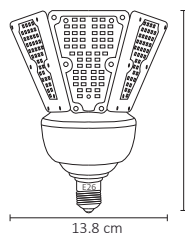
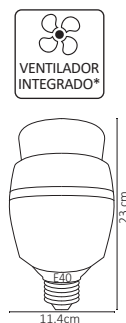

ALA-020

150W

ALA-024

ALA-025

50W

Ejemplo de instalación Punta Poste.  
\*No incluye poste

#	💡	Ⓜ	⚡	☀️	360°	🌈	📏	💎	💧	🔍
Código	Producto	Watts	Voltaje	Lúmenes	Apertura	Temp. Color	Dimensiones	Material	Protección	Observaciones
ALA-019	Lámpara LED Industrial E26 Blanco Frío	30W	90-300V~50/60Hz	3,000LM	120°	6500K	75x145mm	Aluminio + Vidrio + PC	IP20	Base E26
ALA-016	Lámpara LED Industrial E26 Blanco Frío	100W	90-300V~50/60Hz	10,000LM	120°	6500K	98x187mm	PC + Alum. + Plástico	IP20	E26/Ventilador Disipa Calor
ALA-020	Lámpara LED Industrial E40 Blanco Frío	150W	90-300V~50/60Hz	15,000LM	120°	6500K	115x230mm	PC + Alum. + Plástico	IP20	E40/Ventilador Disipa Calor
ALA-024	Lámpara LED Arbotante Punta Poste	50W	90-300V~50/60Hz	6,000LM	120°	3000K	138x190mm	PC + Alum. + Plástico	IP65	Base E26
ALA-025	Lámpara LED Arbotante Punta Poste	50W	90-300V~50/60Hz	6,500LM	120°	6500K	138x190mm	PC + Alum. + Plástico	IP65	Base E26

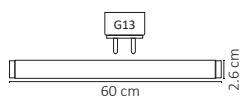

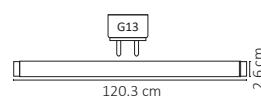
**ATU-001**
**10W**

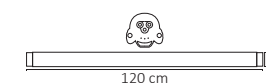
**ATU-002**
**ATU-003**

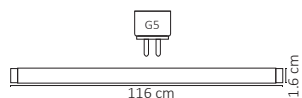
**18W**

**ATU-004**
**ATU-005**

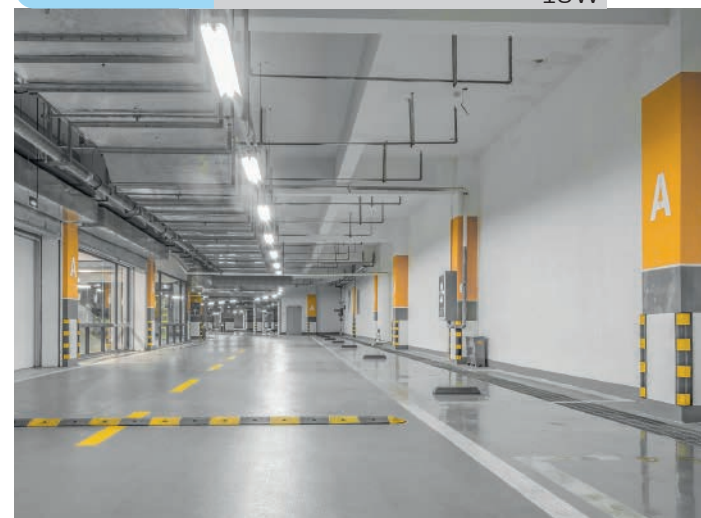
**18W**

**T5**

**ATU-010**
**18W**

**ATU-007**
**ATU-008**

**36W**

#	💡	Ⓜ	⚡	☀️	360°	🌈	📏	💎	💧	🔍
Código	Producto	Watts	Voltaje	Lúmenes	Apertura	Temp. Color	Dimensiones	Material	Protección	Observaciones
ATU-001	Tubo LED T8 Opalino Blanco Frío	10W	90-260V~50/60Hz	950LM	150°	6500K	600x26mm	Plástico + Vidrio	IP20	Conexión 2 Polos
ATU-002	Tubo LED T8 Transparente Blanco Frío	18W	90-260V~50/60Hz	2,000LM	120°	6500K	1203x26mm	Plástico + Vidrio	IP20	Conexión 2 Polos
ATU-003	Tubo LED T8 Opalino Blanco Frío	18W	90-260V~50/60Hz	1,900LM	150°	6500K	1203x26mm	Plástico + Vidrio	IP20	Conexión 2 Polos
ATU-004	Tubo LED T8 con Base Transparente Blanco Frío	18W	90-260V~50/60Hz	2,000LM	120°	6500K	1200x32mm	Plástico	IP20	Hasta 5 Interconexiones
ATU-005	Tubo LED T8 con Base Opanilo Blanco Frío	18W	90-260V~50/60Hz	1,900LM	150°	6500K	1200x32mm	Plástico	IP20	Hasta 5 Interconexiones
ATU-010	Tubo LED T5 Transparente	18W	100-265V~50/60Hz	2,000LM	150°	6500K	1160x16mm	Plástico + Vidrio	IP20	Conexión 2 Polos
ATU-007	Tubo LED T8 -1 PIN- Transparente Blanco Frío	36W	90-260V~50/60Hz	4,000LM	120°	6500K	2410x26mm	Plástico + Aluminio	IP20	Conexión 2 Polos
ATU-008	Tubo T8 -1 PIN- Opalino Blanco Frío	36W	90-260V~50/60Hz	3,800LM	150°	6500K	2410x26mm	Plástico + Aluminio	IP20	Conexión 2 Polos

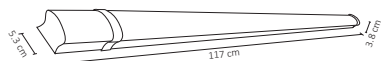



AGA-006

40W

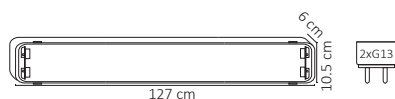

AGA-007

2xG13

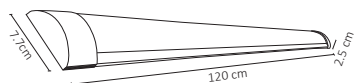

AGA-008

36W



#	💡	Ⓜ	⚡	☀️	360°	🌈	📏	💎	💧	🔍
Código	Producto	Watts	Voltaje	Lúmenes	Apertura	Temp. Color	Dimensiones	Material	Protección	Observaciones
AGA-006	Gabinete Industrial LED Integrado a Prueba de Vapor IP65 Blanco Frío	40W	90-260V~50/60Hz	4,000LM	120°	6500K	1,170x53x60mm	Plástico	IP65	A Prueba de Vapor
AGA-007	Gabinete Industrial a Prueba de Vapor Slim para Dos Tubos T8	2x18W	90-260V~50/60Hz	-	120°	-	1,270x105x60mm	Polycarbonato	IP65	No Incluye Tubos
AGA-008	Gabinete Slim Sobreponer LED Integrado Tipo Regleta Blanco Frío	36W	90-260V~50/60Hz	3,600LM	120°	6500K	1,200x77x25mm	Plástico	IP20	LED Intregado

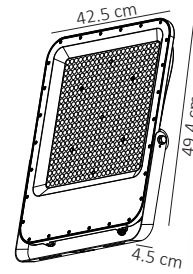
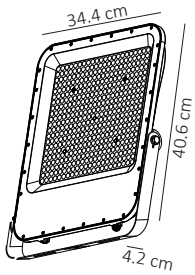

130  
LM/W  
EFICIENCIA

130  
LM/W  
EFICIENCIA

ARE-018

300W

ARE-022

400W

#	💡	Ⓜ	⚡	☀️	360°	🌈	📏	💎	💧	🔍
Código	Producto	Watts	Voltaje	Lúmenes	Apertura	Temp. Color	Dimensiones	Material	Protección	Observaciones
ARE-018	Reflector LED SMD Profesional Slim Blanco Frío	300W	90-277V~50/60Hz	39,000LM	90°	6500K	344x406x42mm	Aluminio + PC	IP66	Fácil Instalación
ARE-022	Reflector LED SMD Profesional Slim Blanco Frío	400W	90-277V~50/60Hz	52,000LM	90°	6500K	425x494x45mm	Aluminio + PC	IP66	Fácil Instalación



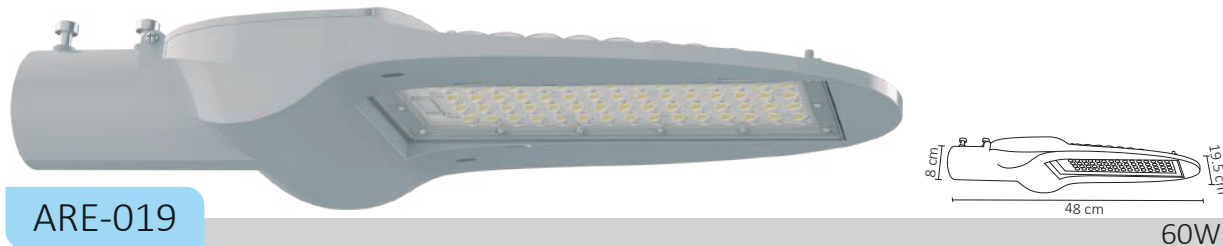

#	💡	Ⓜ	⚡	☀️	🌈	📏	💎	💧	🔍	
Código	Producto	Watts	Voltaje	Lúmenes	Apertura	Temp. Color	Dimensiones	Material	Protección	Observaciones
ARE-019	Luminaria para Calle 60W Blanco Frío	60W	90-277V~50/60Hz	7,500LM	140°	5700K	480x195x80mm	Aluminio + Plástico	IP66	Para Calle
ARE-020	Luminaria para Calle 100W Blanco Frío	100W	90-277V~50/60Hz	12,500LM	150°	5700K	567x233x90mm	Aluminio + Plástico	IP66	Para Calle
ARE-021	Luminaria WallPack para Pared	80W	90-277V~50/60Hz	10,000LM	80x105°	6500K	320x172x130mm	Aluminio + Vidrio	IP66	Para Calle
ACO-010	Fotocelda Base NEMA de 3 Pines	1000W	120-270V~50/60Hz	-	-	-	D. 82x64mm	Plástico	IP65	1800 VA
ACO-011	Tapa para Base NEMA de 3 Pines	-	90-260V~50/60Hz	-	-	-	D. 74x25mm	Plástico	IP65	Fotocelda
ACO-012	Fotocelda Compacta 600W a Prueba de Lluvias	Máx. 600W	90-260V~50/60Hz	-	-	-	90x35x50mm	Plástico y Metal	IP44	Sensor Fotoselda / 6A
ARE-024	Luminaria 100W Punta Poste	100W	90-277V~50/60Hz	12,000LM	150°	5700K	D466x565mm	Aluminio + Vidrio	IP66	NEMA Incluido



ARE-016



ACO-001



Proyectos Solares

12-24V

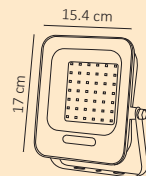

ARE-013



30W



Proyectos Solares

12-24V

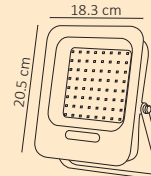

ARE-014



50W

110  
LM/W  
EFICIENCIA

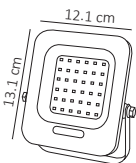

ARE-001

ARE-002



20W

110  
LM/W  
EFICIENCIA

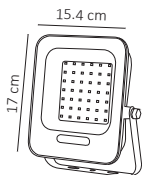

ARE-003

ARE-004



30W

110  
LM/W  
EFICIENCIA

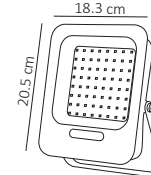

ARE-005

ARE-006



50W

#	💡	Ⓜ	⚡	☀️	360°	🌈	↔️	💎	💧	🔍
Código	Producto	Watts	Voltaje	Lúmenes	Apertura	Temp. Color	Dimensiones	Material	Protección	Observaciones
ARE-016	Luminaria para Muro Blanco Frío	28W	100-260V~50/60Hz	2,500LM	120°	6500K	335x118x54.6mm	Aluminio + Plástico	IP65	Para Muro
ACO-001	Brazo Complemento para ARE-016	-	-	-	-	-	91x64.7x25mm	Metal	IP65	Complemento ARE-016
ARE-013	Reflector LED SMD Cuadrado Slim Blanco Frío	30W	12-24V==	2,850LM	120°	6500K	180x220x45mm	Aluminio + Vidrio	IP66	Para Proyectos Solares
ARE-014	Reflector LED SMD Cuadrado Slim Blanco Frío	50W	12-24V==	4,650LM	120°	6500K	220x280x50mm	Aluminio + Vidrio	IP66	Para Proyectos Solares
ARE-001	Reflector LED SMD Cuadrado Slim Blanco Frío	20W	90-277V~50/60Hz	2,200LM	120°	6500K	121x131x23mm	Aluminio + Vidrio	IP66	Fácil Instalación
ARE-002	Reflector LED SMD Cuadrado Slim Blanco Cálido	20W	90-277V~50/60Hz	2,100LM	120°	3000K	121x131x23mm	Aluminio + Vidrio	IP66	Fácil Instalación
ARE-003	Reflector LED SMD Cuadrado Slim Blanco Frío	30W	90-277V~50/60Hz	3,300LM	120°	6500K	154x170x31mm	Aluminio + Vidrio	IP66	Fácil Instalación
ARE-004	Reflector LED SMD Cuadrado Slim Blanco Cálido	30W	90-277V~50/60Hz	3,150LM	120°	3000K	154x170x31mm	Aluminio + Vidrio	IP66	Fácil Instalación
ARE-005	Reflector LED SMD Cuadrado Slim Blanco Frío	50W	90-277V~50/60Hz	5,500LM	120°	6500K	183x205x32mm	Aluminio + Vidrio	IP66	Fácil Instalación
ARE-006	Reflector LED SMD Cuadrado Slim Blanco Cálido	50W	90-277V~50/60Hz	5,250LM	120°	3000K	183x205x32mm	Aluminio + Vidrio	IP66	Fácil Instalación



110  
LM/W  
EFICIENCIA

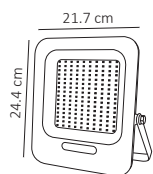

ARE-007

100W

110  
LM/W  
EFICIENCIA

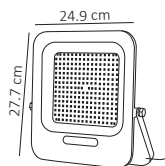

ARE-011

150W

110  
LM/W  
EFICIENCIA

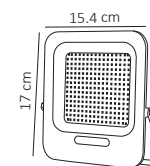

ARE-017

200W

110  
LM/W  
EFICIENCIA

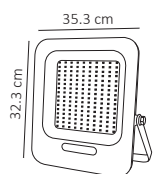

ARE-025

300W

110  
LM/W  
EFICIENCIA

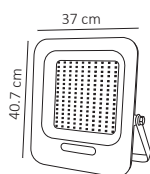

ARE-026

400W

110  
LM/W  
EFICIENCIA

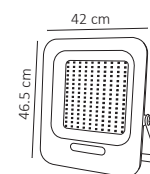

ARE-027

500W

#	💡	Ⓜ	⚡	☀️	360°	🌈	📏	💎	💧	🔍
Código	Producto	Watts	Voltaje	Lúmenes	Apertura	Temp. Color	Dimensiones	Material	Protección	Observaciones
ARE-007	Reflector LED SMD Cuadrado Slim Blanco Frío	100W	90-277V~50/60Hz	11,000LM	120°	6500K	217x244x33mm	Aluminio + Vidrio	IP66	Fácil Instalación
ARE-011	Reflector LED SMD Cuadrado Slim Blanco Frío	150W	90-277V~50/60Hz	16,500LM	120°	6500K	249x277x33mm	Aluminio + Vidrio	IP66	Fácil Instalación
ARE-017	Reflector LED SMD Cuadrado Slim Blanco Frío	200W	90-277V~50/60Hz	22,000LM	120°	6500K	284x218x33mm	Aluminio + Vidrio	IP66	Fácil Instalación
ARE-025	Reflector LED SMD Cuadrado Slim Blanco Frío	300W	90-277V~50/60Hz	33,000LM	120°	6500K	323x353x45mm	Aluminio + Vidrio	IP66	Fácil Instalación
ARE-026	Reflector LED SMD Cuadrado Slim Blanco Frío	400W	90-277V~50/60Hz	44,000LM	120°	6500K	407x370x45mm	Aluminio + Vidrio	IP66	Fácil Instalación
ARE-027	Reflector LED SMD Cuadrado Slim Blanco Frío	500W	90-277V~50/60Hz	55,000LM	120°	6500K	465x420x48mm	Aluminio + Vidrio	IP66	Fácil Instalación

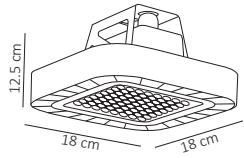

ARE-015

50W

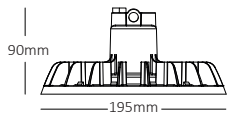

160  
LM/W  
EFICIENCIA

ARE-028

70W



160  
LM/W  
EFICIENCIA

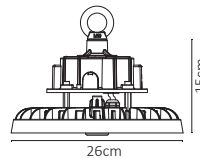

ARE-009

100W



160  
LM/W  
EFICIENCIA

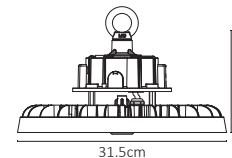

ARE-008

150W

#	💡	Ⓜ	⚡	☀️	360°	🌈	📏	💎	💧	🔍
Código	Producto	Watts	Voltaje	Lúmenes	Apertura	Temp. Color	Dimensiones	Material	Protección	Observaciones
ARE-015	Campana Modular LED Exterior	50W	90-260V~50/60Hz	5,000LM	90°	6500K	180x180x125mm	Aluminio + PC	IP66	Se Pueden Conectar en Gpo.
ARE-028	Campana Industrial Slim LED Blanco Frío	70W	90-300V~50/60Hz	11,200LM	120°	6500k	D.195x91mm	Aluminio + PC	IP66	Atenuador Manual o Eléctrico
ARE-009	Campana Industrial Slim LED Exterior Blanco Frío	100W	100-305V~50/60Hz	16,000LM	120°	5700K	D. 260x150mm	Aluminio + PC	IP66	Atenuador Manual o Eléctrico
ARE-008	Campana Industrial Slim LED Exterior Blanco Frío	150W	100-305V~50/60Hz	24,000LM	90°	5700K	D. 315x155mm	Aluminio + PC	IP66	Atenuador Manual o Eléctrico



#	💡	Ⓜ	⚡	☀️	360°	🌈	↔️	💎	💧	🔍
Código	Producto	Watts	Voltaje	Lúmenes	Apertura	Temp. Color	Dimensiones	Material	Protección	Observaciones
ARE-023	Campana Industrial Slim LED Exterior Blanco Frío	200W	90-305V~50/60Hz	32,000LM	90°	5700K	D. 370x155mm	Aluminio + PC	IP66	Atenuador Manual o Eléctrico
ARE-012	Campana Industrial Slim LED Óptica Blanco Frío	240W	90-300V~50/60Hz	38,400LM	60°	5700K	D. 425x220mm	Aluminio + PC	IP66	Atenuador Manual o Eléctrico
ACO-002	Complemento para Fijar Campana Industrial 100W, 150W y 200W	-	-	-	-	-	114X125X32mm	Metal	-	Incluye 4 Tornillos Hexagonal 4mm de Punto Plana
ACO-003	Complemento para Fijar Campana Industrial 240W	-	-	-	-	-	206x345x60mm	Metal	-	Incluye 4 Tornillos Hexagonal 4mm de Punto Plana
ACO-009	Complemento para Fijar Campana Industrial 200W	-	-	-	-	-	152x180x40mm	Metal	-	Incluye 4 Tornillos Hexagonal 4mm de Punto Plana



# Línea Solar



## ASL-001

REFLECTOR LED SOLAR  
1,000 LÚMENES  
CON PANEL EXTERNO  
Y CONTROL REMOTO

PANEL: Monocristalino 5V 15Wp  
MEDIDA PANEL: 350x350x17mm  
TIEMPO DE CARGA: 5-6 Horas  
DÍAS NUBLADOS: 3 Días  
BATERÍA: 3.2V 10000mAh LiFePO4  
WATTS \*Equivalencia: 100W  
TEMP. COLOR.: 6500K Blanco Frío  
LED: SMD2835 Lumiled  
ATENUABLE: SI  
MEDIDA: 192x132x41mm  
APERTURA: 90°  
MATERIAL: Aluminio Gris  
IP65 Exterior



2,300  
LÚMENES



## ASL-002

REFLECTOR LED SOLAR 2,300 LÚMENES  
CON PANEL EXTERNO Y CONTROL REMOTO

PANEL: Monocristalino 5V 25Wp  
MEDIDA PANEL: 530x350x17mm  
TIEMPO DE CARGA: 5-6 Horas  
DÍAS NUBLADOS: 3 Días  
BATERÍA: 3.2V 20000mAh LiFePO4  
WATTS \*Equivalencia: 200W  
TEMP. COLOR.: 6500K Blanco Frío  
LED: SMD2835 Lumiled  
ATENUABLE: SI  
MEDIDA: 272x199x41mm  
APERTURA: 90°  
MATERIAL: Aluminio Gris  
IP65 Exterior

1,000  
LÚMENES



EN CONDICIONES  
NORMALES\*



## ACO-008

CABLE PARA CARGAR  
LUMINARIA SOLAR, CABLE 50CM  
\*Solo funciona en ASL-002 y ASL-003



\*Potencia equivalente de una bombilla incandescente con un valor estimado de 10-12lm/W



# ASL-004

## LUMINARIA LED SOLAR DE CALLE 2,500 LÚMENES ALL IN ONE CON PANEL SOLAR INTEGRADO

PANEL: Monocristalino 6V 30Wp  
 MEDIDA PANEL: 655x260x4mm  
 TIEMPO DE CARGA: 5-6 Horas  
 DÍAS NUBLADOS: 3 Días  
 BATERÍA: 3.2V 30000mAh LiFePO4  
 WATTS \*Equivalencia: 200W  
 TEMP. COLOR.: 6500K Blanco Frío  
 LED: SMD2835 Lumiled  
 ATENUABLE: SI  
 MEDIDA: 752x266x45mm  
 APERTURA: 90°x130°  
 MATERIAL: Aluminio Gris  
 IP65 Exterior

2,500  
LÚMENES

3,800  
LÚMENES

# ASL-003

## LUMINARIA LED SOLAR 3,800 LÚMENES CON PANEL EXTERNO Y CONTROL REMOTO

PANEL: Monocristalino 5V 40Wp  
 MEDIDA PANEL: 670x350x25mm  
 TIEMPO DE CARGA: 5-6 Horas  
 DÍAS NUBLADOS: 3 Días  
 BATERÍA: 3.2V 40000mAh LiFePO4  
 WATTS \*Equivalencia: 300W  
 TEMP. COLOR.: 6500K Blanco Frío  
 LED: SMD2835 Lumiled  
 ATENUABLE: SI  
 MEDIDA: 532x240x69mm  
 APERTURA: 120°x100°  
 MATERIAL: Aluminio Gris  
 IP65 Exterior



\*Potencia equivalente de una bombilla incandescente con un valor estimado de 10-12lm/W

\*Altura máxima recomendada 5m.

\*Incluye accesorio de instalación y control remoto.



\*Potencia equivalente de una bombilla incandescente con un valor estimado de 10-12lm/W.

\*Altura máxima recomendada 4m.

\*Incluye accesorio de instalación y control remoto.

\*Incluye solo una luminaria por caja.



Vista Trasera

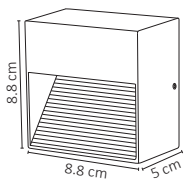

ADE-401

ADE-402



3W



ADE-201

1xMR16



ADE-202

1xMR16

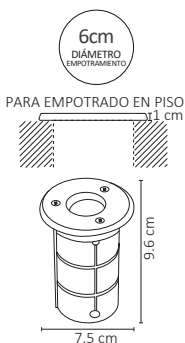

ADE-203

ADE-204



1W

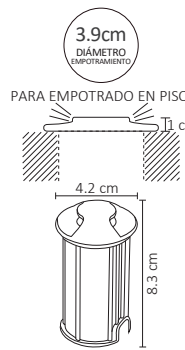

ADE-205

ADE-206



1W

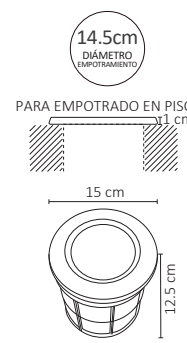

ADE-207

ADE-208

10W



#	💡	Ⓜ	⚡	☀️	360°	🌈	📏	💎	💧	🔍
Código	Producto	Watts	Voltaje	Lúmenes	Apertura	Temp. Color	Dimensiones	Material	Protección	Observaciones
ADE-401	Luminaria de Cortesía Blanco Frío	3W	90-260V~50/60Hz	80LM	90°	6500K	88x88x50mm	Aluminio + Plástico	IP54	Ideal para Escaleras, Pasillos, etc.
ADE-402	Luminaria de Cortesía Blanco Cálido	3W	90-260V~50/60Hz	75LM	90°	3000K	88x88x50mm	Aluminio + Plástico	IP54	Ideal para Escaleras, Pasillos, etc.
ADE-201	Luminaria de Piso Vidrio Templado	Máx. 50W	90-260V~50/60Hz	-	Máx. 90°	-	D. 100x60mm	Plástico + Vidrio Templ.	IP67	Emp./MR16/No Incluye Lámpara
ADE-202	Luminaria de Piso Satín y Vidrio Templado	Máx. 50W	90-260V~50/60Hz	-	Máx. 90°	-	D. 100x100mm	Plástico + Alum. + Vidrio	IP67	Emp./MR16/No Incluye Lámpara
ADE-203	Luminaria Piso LED Mini Integrado Blanco Frío	1W	90-260V~50/60Hz	80LM	60°	6500K	D. 75x96mm	Plástico + Alum. + Vidrio	IP67	Empotrable/Diam. Emp. 60mm
ADE-204	Luminaria Piso LED Mini Integrado Blanco Cálido	1W	90-260V~50/60Hz	75LM	60°	3000K	D. 75x96mm	Plástico + Alum. + Vidrio	IP67	Empotrable/Diam. Emp. 60mm
ADE-205	Luminaria de Piso Empotrable Blanco Frío	1W	90-260V~50/60Hz	80LM	60°/60°	6500K	D. 42x83mm	Aluminio + Plástico	IP67	Empotrable/Diam. Emp. 39mm
ADE-206	Luminaria de Piso Empotrable Blanco Cálido	1W	90-260V~50/60Hz	75LM	60°/60°	3000K	D. 42x83mm	Aluminio + Plástico	IP67	Empotrable/Diam. Emp. 39mm
ADE-207	Luminaria Piso LED Óptica Exterior Blanco Frío	10W	90-260V~50/60Hz	800LM	40°	6500K	D. 150x125mm	Plástico + Acero + Vidrio	IP67	Empotrable/Diam. Emp. 145mm
ADE-208	Luminaria Piso LED Óptica Exterior Blanco Cálido	10W	90-260V~50/60Hz	750LM	40°	3000K	D. 150x125mm	Plástico + Acero + Vidrio	IP67	Empotrable/Diam. Emp. 145mm



ADE-301

1xMR16



1xMR16

ADE-305

ADE-306

10W



ACO-004

#	Lightbulb	W	Lightning Bolt	Sun	Color	Double Arrow	Diamond	Water Drop	Magnifying Glass	
Código	Producto	Watts	Voltaje	Lúmenes	Apertura	Temp. Color	Dimensiones	Material	Protección	Observaciones
ADE-301	Luminaria para Jardín con Base Sobreponer	Max. 50W	90-260V~50/60Hz	-	-	-	121x111x92mm	Plástico + Vidrio + Alum.	IP65	Sob./MR16/No Incluye Lámpara
ADE-302	Luminaria para Jardín Estaca	Máx. 50W	90-260V~50/60Hz	-	-	-	365x75mm	Aluminio + Vidrio	IP54	MR16/No Incluye Lámpara
ADE-305	Luminaria LED Jardín Estaca Negra Blanco Frío	10W	90-260V~50/60Hz	850LM	6500K	6500K	110x390x150mm	Aluminio + Vidrio	IP65	Estaca para Jardín
ADE-306	Luminaria LED Jardín Estaca Negra Blanco Cálido	10W	90-260V~50/60Hz	800LM	3000K	3000K	110x390x150mm	Aluminio + Vidrio	IP65	Estaca para Jardín
ACO-004	Complemento ADE-305 y ADE-306 para Sobreponer en Piso	-	-	-	-	-	140x50mm	Aluminio	IP65	Base Complemento



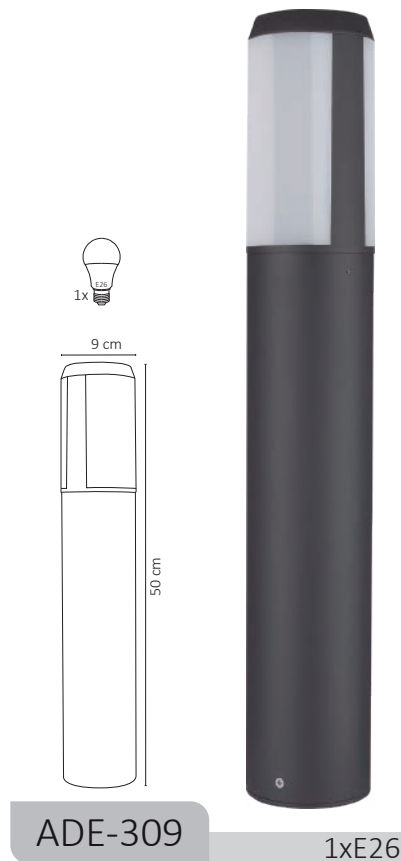
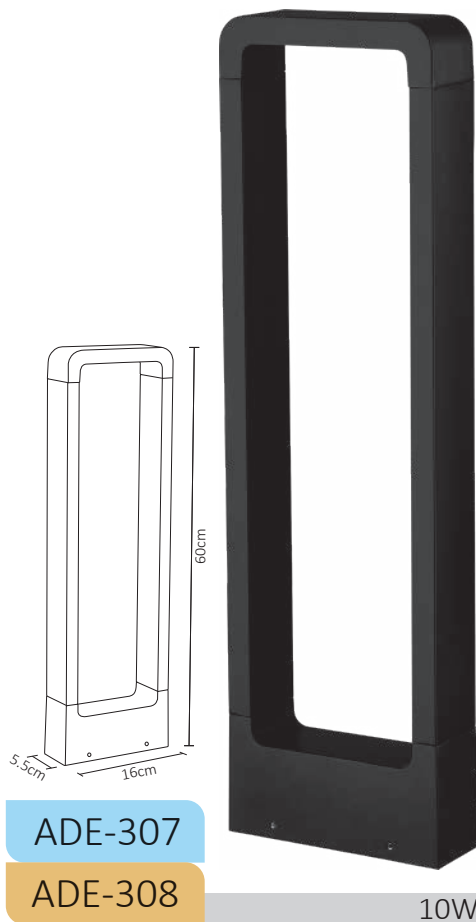
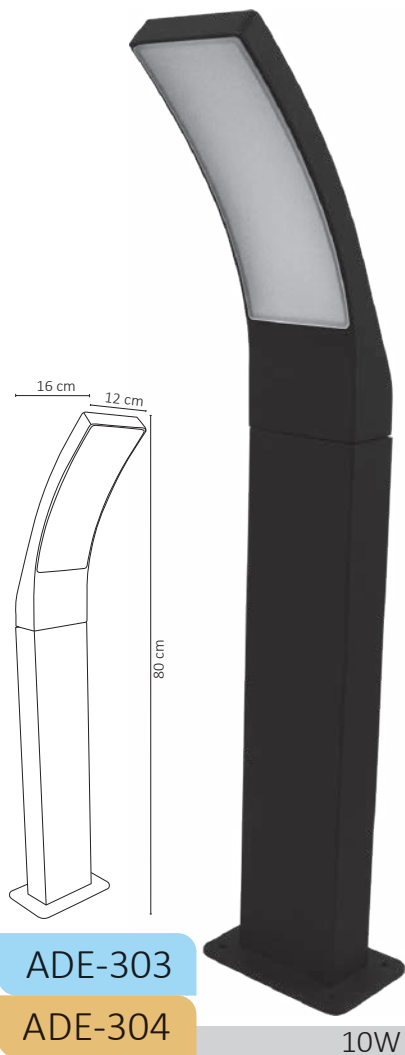

#	Lightbulb	W	Lightning Bolt	Sun	Color Wheel	Double Arrow	Diamond	Water Drop	Magnifying Glass	
Código	Producto	Watts	Voltaje	Lúmenes	Apertura	Temp. Color	Dimensiones	Material	Protección	Observaciones
ADE-303	Luminaria Tipo Mini Poste Exterior Blanco Frío	10W	90-260V~50/60Hz	900LM	90°	6500K	120x800x160mm	Aluminio + PC	IP54	Sobreponer en Piso
ADE-304	Luminaria Tipo Mini Poste Exterior Blanco Cálido	10W	90-260V~50/60Hz	850LM	90°	3000K	120x800x160mm	Aluminio + PC	IP54	Sobreponer en Piso
ADE-307	Luminaria LED Tubular Rectangular Blanco Frío	10W	90-260V~50/60Hz	900LM	120°/120°	6500K	160x600x55mm	Aluminio + Plástico	IP54	Sobreponer en Piso
ADE-308	Luminaria LED Tubular Rectangular Blanco Cálido	10W	90-260V~50/60Hz	850LM	120°/120°	3000K	160x600x55mm	Aluminio + Plástico	IP54	Sobreponer en Piso
ADE-309	Luminaria Mini Poste Cilindro Sob. Aluminio Gris	Máx. 50W	90-260V~50/60Hz	-	Máx. 300°	-	90x500mm	Aluminio + PC	IP54	Sob./E26/Sin Lámpara
ADE-010	Luminaria de Pared Exterior Blanco Frío	10W	90-260V~50/60Hz	850LM	90°	6500K	80x240x160mm	Aluminio + Plástico	IP54	Sobreponer en Pared
ADE-011	Luminaria de Pared Exterior Blanco Cálido	10W	90-260V~50/60Hz	800LM	90°	3000K	80x240x160mm	Aluminio + Plástico	IP54	Sobreponer en Pared



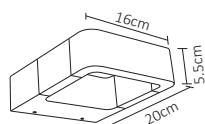

ADE-014

ADE-015

10W

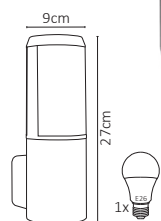

ADE-016

1xE26

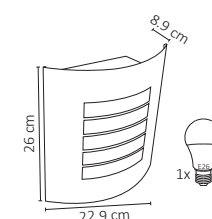

ADE-005

1xE26

#	💡	Ⓜ	⚡	☀️	360°	🌈	📏	💎	💧	🔍
Código	Producto	Watts	Voltaje	Lúmenes	Apertura	Temp. Color	Dimensiones	Material	Protección	Observaciones
ADE-014	Luminaria LED de Pared Tubular Aluminio Negro Exterior Blanco Frío	10W	90-260V~50/60Hz	850LM	120°/120°	6500K	200x160x55mm	Aluminio + Plástico	IP54	Sobreponer/Doble Disparo
ADE-015	Luminaria LED de Pared Tubular Aluminio Negro Exterior Blanco Cálido	10W	90-260V~50/60Hz	800LM	120°/120°	3000K	200x160x55mm	Aluminio + Plástico	IP54	Sobreponer/Doble Disparo
ADE-016	Luminaria Pared Cilíndrica Más PC Alum. Gris	Máx. 50W	90-260V~50/60Hz	-	Máx. 300°	-	90x270x130mm	Aluminio + PC	IP54	Sob./E26/Sin Lámpara
ADE-005	Luminaria de Pared Pantalla con Rejilla	Máx. 50W	90-260V~50/60Hz	-	Máx. 120°	-	229x260x89mm	Acero Inox. + Plástico	IP54	Sob./E26/Sin Lámpara

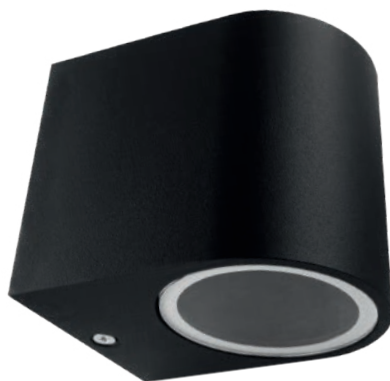
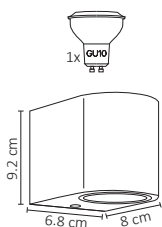

ADE-003

1xGU10

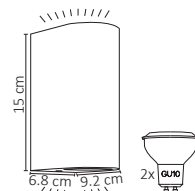

ADE-004

2xGU10

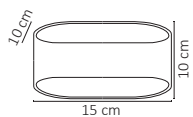

ADE-001

ADE-002

6W

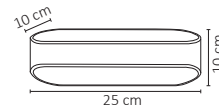

ADE-007

ADE-008

12W

#	Lightbulb	W	V	L	A	Temp. Color	D	M	P	O
Código	Producto	Watts	Voltaje	Lúmenes	Apertura	Temp. Color	Dimensiones	Material	Protección	Observaciones
ADE-003	Luminaria de Pared Cilindro	Máx. 50W	90-260V~50/60Hz	-	Máx. 90°	-	68x80x92mm	Alum. + Vidrio + Plástico	IP54	Sob./GU10/Sin Lámpara
ADE-004	Luminaria de Pared Cilindro Doble	Máx. 50W	90-260V~50/60Hz	-	Máx. 90°	-	68x80x92mm	Alum. + Vidrio + Plástico	IP54	Sob./GU10/Sin Lámpara
ADE-001	Luminaria de Pared LED Exterior Blanco Frío	6W	90-260V~50/60Hz	500LM	45°/45°	6500K	150x100x100mm	Aluminio + Plástico	IP54	Sobreponer
ADE-002	Luminaria de Pared LED Exterior Blanco Cálido	6W	90-260V~50/60Hz	450LM	45°/45°	3000K	150x100x100mm	Aluminio + Plástico	IP54	Sobreponer
ADE-007	Luminaria de Pared LED Exterior Blanco Frío	12W	90-260V~50/60Hz	900LM	45°/45°	6500K	250x100x100mm	Aluminio + Plástico	IP54	Sobreponer
ADE-008	Luminaria de Pared LED Exterior Blanco Cálido	12W	90-260V~50/60Hz	850LM	45°/45°	3000K	250x100x100mm	Aluminio + Plástico	IP54	Sobreponer

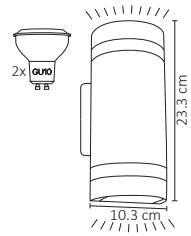

ADE-006

2xGU10

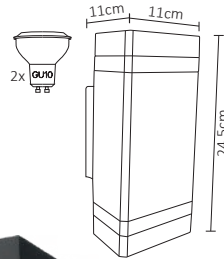

ADE-012

2xGU10

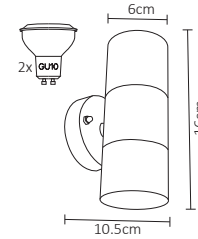

ADE-013

2xGU10

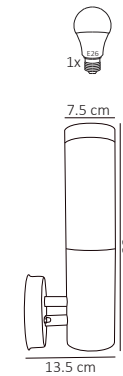

ADE-017

1xE26

#	💡	⚡	☀️	360°	🌈	📏	💎	💧	🔍	
Código	Producto	Watts	Voltaje	Lúmenes	Apertura	Temp. Color	Dimensiones	Material	Protección	Observaciones
ADE-006	Luminaria Cilindro Doble Aro	Máx. 50W	90-260V~50/60Hz	-	Máx. 90°/90°	-	103x233x108mm	Alum. + Plástico + PC	IP54	Sob./2xGU10/Sin Lámpara
ADE-012	Luminaria de Pared Rectangular Doble Aluminio Negro Exterior Base GU10	Máx. 50W	90-260V~50/60Hz	-	Máx. 80°/80°	-	110x250x110mm	Alum. + Plástico + PC	IP54	Sob./2xGU10/Sin Lámpara
ADE-013	Luminaria de Pared Cilindro Doble Satín Exterior Base GU10	Máx. 50W	90-260V~50/60Hz	-	Máx. 80°/80°	-	60x160x105mm	Aluminio + Vidrio	IP54	Sob./2xGU10/Sin Lámpara
ADE-017	Lum. Pared Cilindro Vertical Cubierta Opalina	Máx. 50W	90-260V~50/60Hz	-	Máx. 80°/80°	-	75x330x135mm	PC + Acero Inoxidable	IP54	Sob./E26/Sin Lámpara

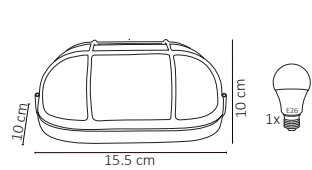

ADE-018

1xE26

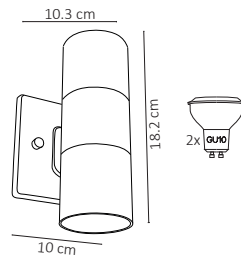

ADE-019

2xGU10

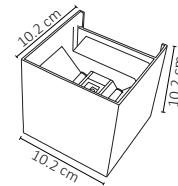

ADE-020

ADE-021

6W

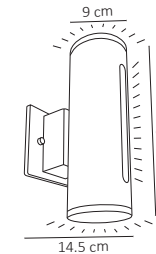

ADE-022

ADE-023

11W

#	💡	Ⓜ	⚡	☀️	🌈	📏	💎	💧	🔍	
Código	Producto	Watts	Voltaje	Lúmenes	Apertura	Temp. Color	Dimensiones	Material	Protección	Observaciones
ADE-018	Lum. Pared Nautica Rejilla Negra Cub. Opalina	Máx. 50W	90-260V~50/60Hz	-	-	-	145x100x100mm	Aluminio + Vidrio	IP54	Sob./1xE26/Sin Lámpara
ADE-019	Luminaria Pared Cilindro Doble Negro Mate	Máx. 50W	90-260V~50/60Hz	-	-	-	103x182x100mm	Aluminio + Vidrio Temp.	IP54	Sob./2xGU10/Sin Lámpara
ADE-020	Luminaria Led Pared Cubo Doble Disparo y Angulo Ajustable Blanco Frío Negro Mate	6W	90-260V~50/60Hz	360LM	2x45°	6500K	102x102mm	Aluminio	IP54	Fácil Instalación Ángulo Ajustable
ADE-021	Luminaria Led Pared Cubo Doble Disparo y Angulo Ajustable Blanco Cálido Negro Mate	6W	90-260V~50/60Hz	350LM	2x45°	3000K	102x102mm	Aluminio	IP54	Fácil Instalación Ángulo Ajustable
ADE-022	Luminaria Pared Cilindro Doble con Lineal Frontal Blanco Frío	11W	90-260V~50/60Hz	700LM	2x150°	6500K	114x280x145mm	Aluminio + PC	IP54	Sobreponer en Pared
ADE-023	Luminaria Pared Cilindro Doble con Lineal Frontal Blanco Cálido	11W	90-260V~50/60Hz	650LM	2x150°	3000K	114x280x145mm	Aluminio + PC	IP54	Sobreponer en Pared



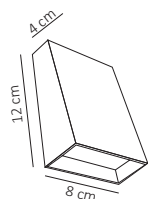

ADE-024

ADE-025

5W

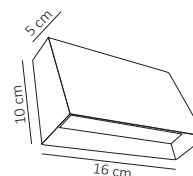

ADE-026

ADE-027

10W

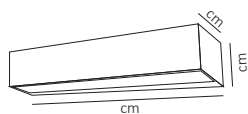

ADE-028

ADE-029

18W

#	Lightbulb	W	Lightning Bolt	Sun	Color Wheel	Double Arrow	Diamond	Water Drop	Magnifying Glass	
Código	Producto	Watts	Voltaje	Lúmenes	Apertura	Temp. Color	Dimensiones	Material	Protección	Observaciones
ADE-024	Luminaria LED de Pared Prisma Disparo Sencillo Aluminio Negro Exterior Blanco Frío	5W	90-260V~50/60Hz	300LM	120°	6500K	120x80x40mm	Aluminio Negro	IP54	Disparo Sencillo Pared
ADE-025	Luminaria LED de Pared Prisma Disparo Sencillo Aluminio Negro Exterior Blanco Cálido	5W	90-260V~50/60Hz	280LM	120°	3000K	120x80x40mm	Aluminio Negro	IP54	Disparo Sencillo Pared
ADE-026	Luminaria LED de Pared Prisma Disparo Sencillo Aluminio Negro Exterior Blanco Frío	10W	90-260V~50/60Hz	600LM	120°	6500K	160x100x50mm	Aluminio Negro	IP54	Disparo Sencillo Pared
ADE-027	Luminaria LED de Pared Prisma Disparo Sencillo Aluminio Negro Exterior Blanco Cálido	10W	90-260V~50/60Hz	550LM	120°	3000K	160x100x50mm	Aluminio Negro	IP54	Disparo Sencillo Pared
ADE-028	Luminaria Pared Barra Lineal Negro Blanco Frío	18W	90-260V~50/60Hz	1250LM	120°	6500K	mm	Aluminio + Vidrio	IP54	Sob. / Para Escaleras
ADE-029	Luminaria Pared Barra Lineal Negro Blanco Cálido	18W	90-260V~50/60Hz	1240LM	120°	3000K	mm	Aluminio + Vidrio	IP54	Sob. / Para Escaleras



ADE-501

12 x E26

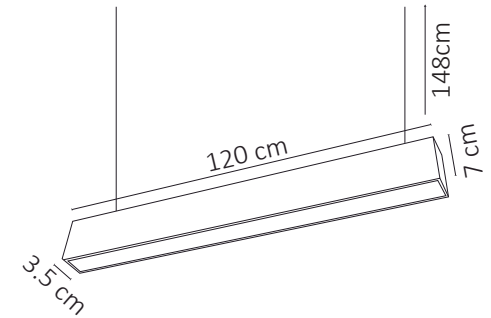

ADE-609

ADE-610

40W

Código	Producto	Watts	Voltaje	Lúmenes	Apertura	Temp. Color	Dimensiones	Material	Protección	Observaciones
ADE-501	Extensión de Sockets para 12 Bulbos	Máx. 50W	90-260V~50/60Hz	-	Máx. 320°	-	Extensión 7.5m	Plástico	IP65	12 Bases E26/No incluye focos
ADE-609	Luminaria LED Colgante Negro Blanco Frío	40W	90-260V~50/60Hz	3,100LM	120°	6500K	1200x35x70mm	Aluminio + PC	IP20	Med. Cable: 148 cm
ADE-610	Luminaria LED Colgante Negro Blanco Cálido	40W	90-260V~50/60Hz	3,400LM	120°	3000K	1200x35x70mm	Aluminio + PC	IP20	Med. Cable: 148 cm

# Decorativo Colgante y de Techo

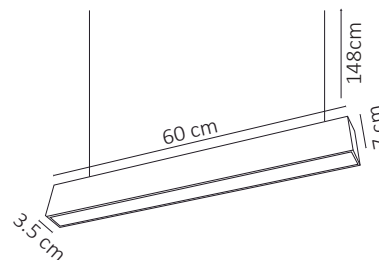
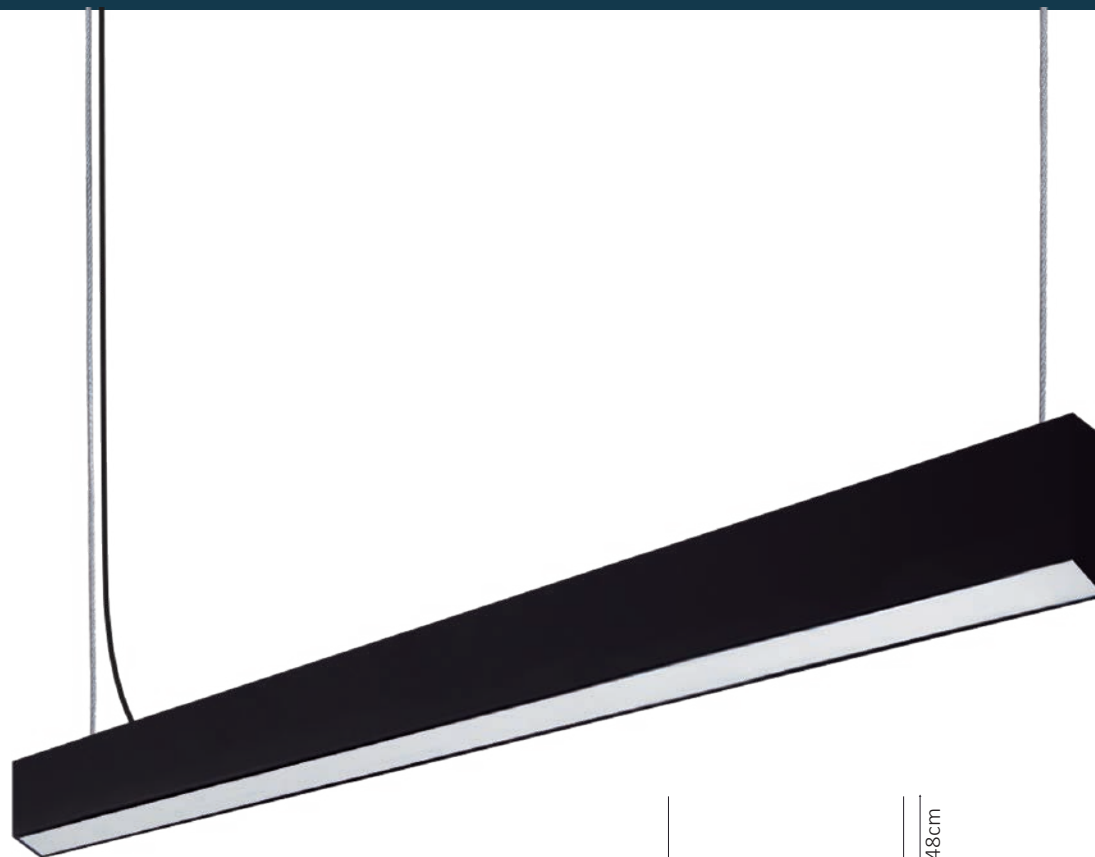

ADE-611

ADE-612

20W

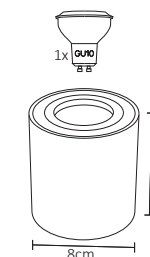

ADE-701

1xGU10

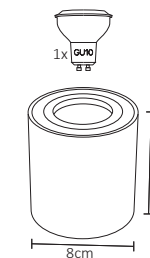

ADO-702

1xGU10



Código	Producto	Watts	Voltaje	Lúmenes	Apertura	Temp. Color	Dimensiones	Material	Protección	Observaciones
ADE-611	Luminaria LED Colgante Negro Blanco Frío	20W	90-260V~50/60Hz	1,550LM	120°	6500K	600x35x70mm	Alum. + Policarbonato	IP20	Sob./1xGU10/No incluye lámpara
ADE-612	Luminaria LED Colgante Negro Blanco Cálido	20W	90-260V~50/60Hz	1,500LM	120°	3000K	600x35x70mm	Alum. + Policarbonato	IP20	Sob./1xGU10/No incluye lámpara
ADE-701	Luminaria Sobreponer Techo Cilíndrico Dirigible Aluminio Blanco para GU10	Máx. 50W	90-260V~50/60Hz	-	Máx. 120°	-	D. 80x115mm	Aluminio	IP20	Sob./1xGU10/No incluye lámpara
ADE-702	Luminaria Sobreponer Techo Cilíndrico Dirigible Aluminio Negro para GU10	Máx. 50W	90-260V~50/60Hz	-	Máx. 120°	-	D. 80x115mm	Aluminio	IP20	Sob./1xGU10/No incluye lámpara





ADE-601

1xE26

ADE-602

1xE26

ADE-603

1xE26

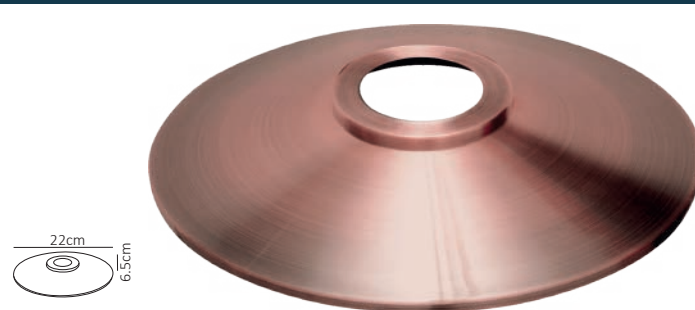

ACO-005



ACO-006

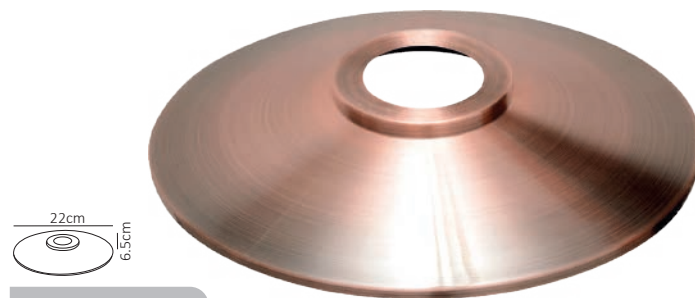

ACO-007

#	💡	Ⓜ	⚡	☀️	🌈	📏	💎	💧	🔍	
Código	Producto	Watts	Voltaje	Lúmenes	Apertura	Temp. Color	Dimensiones	Material	Protección	Observaciones
ADE-601	Colgante Vintage Bulbo E26 Oro Rosado	Máx. 50W	90-260V~50/60Hz	-	Máx. 320°	-	D. 49x60mm	Aluminio + Nylon	IP20	No incluye lámpara E26 Medida del cable: 138cm
ADE-602	Colgante Vintage Bulbo E26 Negro Pulido	Máx. 50W	90-260V~50/60Hz	-	Máx. 320°	-	D. 49x60mm	Aluminio + Nylon	IP20	No incluye lámpara E26 Medida del cable: 138cm
ADE-603	Colgante Vintage Bulbo E26 Cobre Antiguo	Máx. 50W	90-260V~50/60Hz	-	Máx. 320°	-	D. 49x60mm	Aluminio + Nylon	IP20	No incluye lámpara E26 Medida del cable: 138cm
ACO-005	Complemento Redondo p/ADE-601 Oro Rosado	-	-	-	-	-	D. 220x65mm	Aluminio	IP20	No incluye colgante
ACO-006	Complemento Redondo p/ADE-602 Negro Pulido	-	-	-	-	-	D. 220x65mm	Aluminio	IP20	No incluye colgante
ACO-007	Complemento Redondo p/ADE-603 Cobre Antiguo	-	-	-	-	-	D. 220x65mm	Aluminio	IP20	No incluye colgante

# Decorativos Colgantes

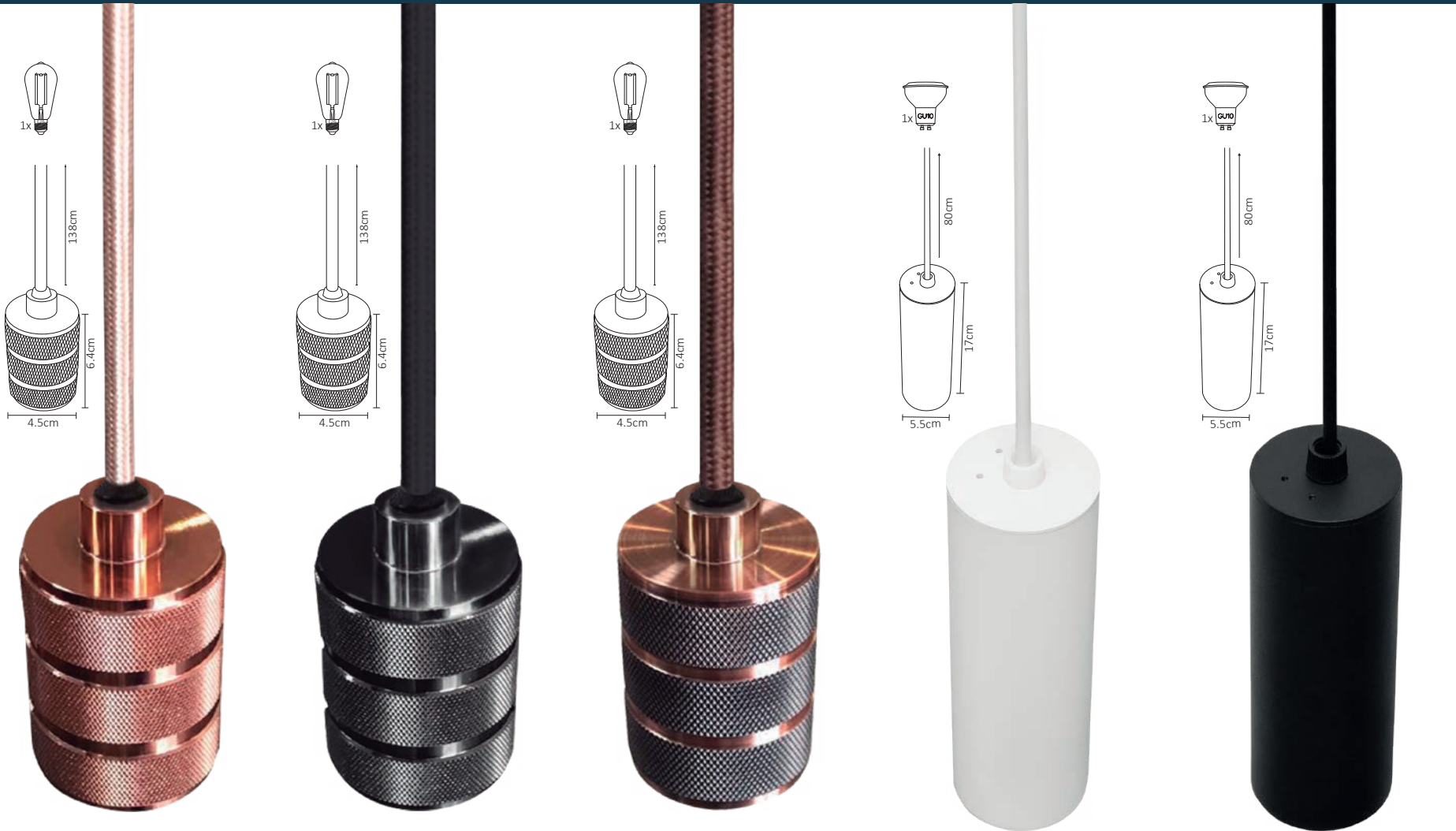

ADE-604

1xE26

ADE-605

1xE26

ADE-606

1xE26

ADE-607

1xGU10

ADE-608

1xGU10

#	💡	Ⓜ	⚡	☀️	🌈	📏	💎	💧	🔍	
Código	Producto	Watts	Voltaje	Lúmenes	Apertura	Temp. Color	Dimensiones	Material	Protección	Observaciones
ADE-604	Colgante Cilíndrico Bulbo E26 Oro Rosado	Max. 50W	90-260V~50/60Hz	-	Máx. 320°	-	D. 45x64mm	Aluminio + Nailon	IP20	No incluye lámpara E26 Medida del cable: 138cm
ADE-605	Colgante Cilíndrico Bulbo E26 Negro Pulido	Máx. 50W	90-260V~50/60Hz	-	Máx. 320°	-	D. 45x64mm	Aluminio + Nailon	IP20	No incluye lámpara E26 Medida del cable: 138cm
ADE-606	Colgante Cilíndrico Bulbo E26 Cobre Antiguo	Máx. 50W	90-260V~50/60Hz	-	Máx. 320°	-	D. 45x64mm	Aluminio + Nailon	IP20	No incluye lámpara E26 Medida del cable: 138cm
ADE-607	Colgante Cubierta Cilíndrica Aluminio Blanco	Máx. 50W	90-260V~50/60Hz	-	Máx. 120°	-	D. 170x55mm	Aluminio	IP20	No incluye lámpara GU10 Medida del cable: 80cm
ADE-608	Colgante Cubierta Cilíndrica Aluminio Negro	Máx. 50W	90-260V~50/60Hz	-	Máx. 120°	-	D. 170x55mm	Aluminio	IP20	No incluye lámpara GU10 Medida del cable: 80cm

5.5cm  
DIÁMETRO  
EMPOTRAMIENTO

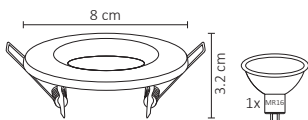

5.5cm  
DIÁMETRO  
EMPOTRAMIENTO

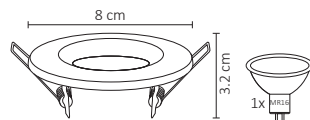

5.5cm  
DIÁMETRO  
EMPOTRAMIENTO

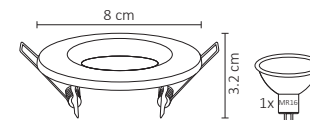

ADE-101

1xMR16

ADE-102

1xMR16

ADE-103

1xMR16

7cm  
DIÁMETRO  
EMPOTRAMIENTO

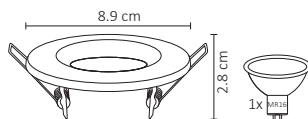

7cm  
DIÁMETRO  
EMPOTRAMIENTO

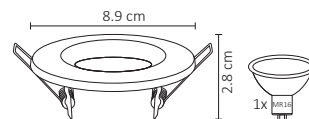

7cm  
DIÁMETRO  
EMPOTRAMIENTO

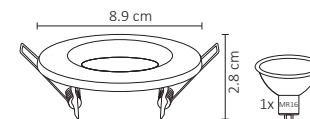

ADE-104

1xMR16

ADE-105

1xMR16

ADE-106

1xMR16



Código	Producto	Watts	Voltaje	Apertura	Dimensiones	Material	Protección	Observaciones
ADE-101	Empotrable Fijo Aro Metálico Negro	Máx. 50W	90-260V~50/60Hz	Máx. 120°	D. 80x32mm	Metal	IP20	Base MR16 / No Incluye Lámpara / Emp. 55mm
ADE-102	Empotrable Fijo Aro Metálico Blanco	Máx. 50W	90-260V~50/60Hz	Máx. 120°	D. 80x32mm	Metal	IP20	Base MR16 / No Incluye Lámpara / Emp. 55mm
ADE-103	Empotrable Fijo Aro Metálico Satín	Máx. 50W	90-260V~50/60Hz	Máx. 120°	D. 80x32mm	Metal	IP20	Base MR16 / No Incluye Lámpara / Emp. 55mm
ADE-104	Empotrable Dirigible Aro Metálico Negro	Máx. 50W	90-260V~50/60Hz	Máx. 120°	D. 89x28mm	Metal	IP20	Base MR16 / No Incluye Lámpara / Emp. 70mm
ADE-105	Empotrable Dirigible Aro Metálico Blanco	Máx. 50W	90-260V~50/60Hz	Máx. 120°	D. 89x28mm	Metal	IP20	Base MR16 / No Incluye Lámpara / Emp. 70mm
ADE-106	Empotrable Dirigible Aro Metálico Satín	Máx. 50W	90-260V~50/60Hz	Máx. 120°	D. 89x28mm	Metal	IP20	Base MR16 / No Incluye Lámpara / Emp. 70mm



# Aros Decorativos Cuadrados

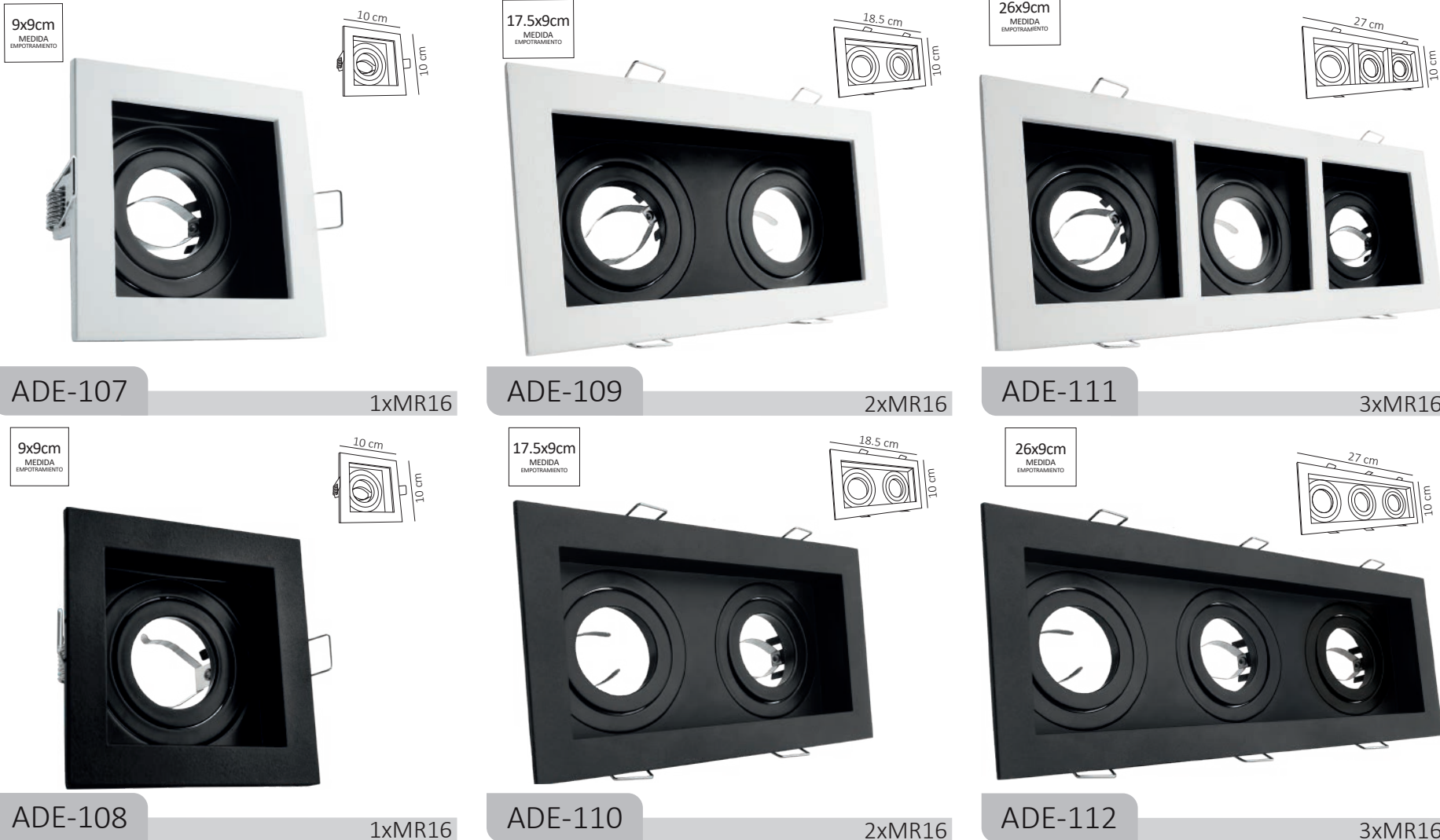

#	💡	Ⓜ	⚡	☀️	📏	💎	💧	🔍
Código	Producto	Watts	Voltaje	Apertura	Dimensiones	Material	Protección	Observaciones
ADE-107	Empotrable Dirigible para Spot Sencillo Blanco	Máx. 50W	90-260V~50/60Hz	Máx. 120°	100x100x40mm	Metal	IP20	1xMR16/No Incluye Lámpara/Emp. 90x90mm
ADE-108	Empotrable Dirigible para Spot Sencillo Negro	Máx. 50W	90-260V~50/60Hz	Máx. 120°	100x100x40mm	Metal	IP20	1xMR16/No Incluye Lámpara/Emp. 90x90mm
ADE-109	Empotrable Dirigible para Spot Doble Blanco	Máx. 50W	90-260V~50/60Hz	Máx. 120°	185x100x40mm	Metal	IP20	2xMR16/No Incluye Lámpara/Emp. 175x90mm
ADE-110	Empotrable Dirigible para Spot Doble Negro	Máx. 50W	90-260V~50/60Hz	Máx. 120°	185x100x40mm	Metal	IP20	2xMR16/No Incluye Lámpara/Emp. 175x90mm
ADE-111	Empotrable Dirigible para Spot Triple Blanco	Máx. 50W	90-260V~50/60Hz	Máx. 120°	270x100x40mm	Metal	IP20	3xMR16/No Incluye Lámpara/Emp. 260x90mm
ADE-112	Empotrable Dirigible para Spot Triple Negro	Máx. 50W	90-260V~50/60Hz	Máx. 120°	270x100x40mm	Metal	IP20	3xMR16/No Incluye Lámpara/Emp. 260x90mm



**APL-101**



**APL-102**



\*Excepto 3 años de APL-107

#	💡	●	⚡	ⓐ	🕒	↔️	💎	💧	🔍
Código	Producto	Color	Voltaje	Corriente Eléctrica	Atenuador	Dimensiones	Material	Protección	Observaciones
APL-101	Placa Apagador 1 Interruptor y 3 Vías	Gris	90-277V~50/60Hz	15A	No	77x124mm	Acero Inox. + PC + Hierro Galvanizado	IP20	Interruptor 3 Vías
APL-102	Placa Apagador de 2 Interruptores y 3 Vías	Gris	90-277V~50/60Hz	15A	No	77x124mm	Acero Inox. + PC + Hierro Galvanizado	IP20	Interruptor 3 Vías

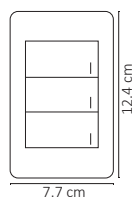

APL-103

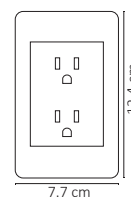

APL-104

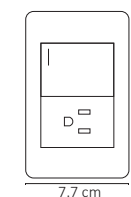

APL-105

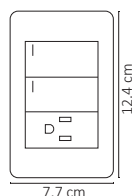

APL-106

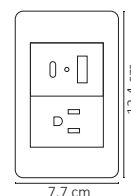

APL-107

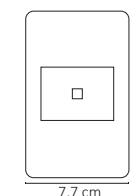

APL-108



Código	Producto	Color	Voltaje	Corriente Eléctrica	Atenuador	Dimensiones	Material	Protección	Observaciones
APL-103	Placa Apagador de 3 Interruptores y 3 Vías	Gris	90-277V~50/60Hz	15A	No	77x124mm	Acero Inox. + PC + Hierro Galvanizado	IP20	Interruptor 3 Vías
APL-104	Placa de Contacto Doble	Gris	90-277V~50/60Hz	15A	No	77x124mm	Acero Inox. + PC + Hierro Galvanizado	IP20	2 Contactos
APL-105	Placa de Contacto y Apagador 1 Interruptor 3 Vías	Gris	90-277V~50/60Hz	15A	No	77x124mm	Acero Inox. + PC + Hierro Galvanizado	IP20	Interruptor 3 Vías
APL-106	Placa de Contacto y Apagador 2 Interruptores 3 Vías	Gris	90-277V~50/60Hz	15A	No	77x124mm	Acero Inox. + PC + Hierro Galvanizado	IP20	Interruptor 3 Vías
APL-107	Placa de Contacto y 2 Salidas Usb	Gris	90-277V~50/60Hz	15A	No	77x124mm	Acero Inox. + PC + Hierro Galvanizado	IP20	USB SALIDA 5V=Max 2.1A
APL-108	Placa de Contacto Telefónico	Gris	N/A	N/A	No	77x124mm	Acero Inox. + PC + Hierro Galvanizado	IP20	Conector: RJ11



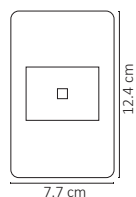

**APL-109**

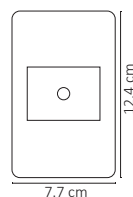

**APL-110**

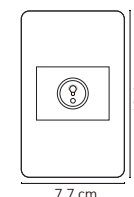

**APL-111**

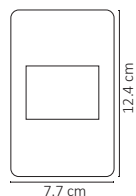

**APL-112**

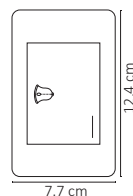

**APL-113**

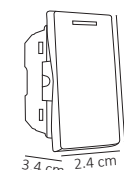

**APL-001**



Código	Producto	Color	Voltaje	Corriente Eléctrica	Atenuador	Dimensiones	Material	Protección	Observaciones
APL-109	Placa de Contacto Red Lan Tipo RJ45 CAT5	Gris	N/A	N/A	No	77x124mm	Acero Inox. + PC + Hierro Galvanizado	IP20	RJ45 CAT5
APL-110	Placa de Contacto Coaxial para Televisión	Gris	N/A	N/A	No	77x124mm	Acero Inox. + PC + Hierro Galvanizado	IP20	Con Toma TV
APL-111	Placa de Contacto Atenuador Iluminación de 100W	Gris	100-127V~50/60Hz	0.78A	Si	77x124mm	Acero Inox. + PC + Hierro Galvanizado	IP20	Atenuador
APL-112	Placa Tapa Ciega	Gris	N/A	N/A	No	77x124mm	Acero Inox. + PC + Hierro Galvanizado	IP20	Decorativo
APL-113	Placa de Contacto Timbre	Gris	90-127V~50/60Hz	15A	No	77x124mm	Acero Inox. + PC + Hierro Galvanizado	IP20	Timbre
APL-001	Módulo Apagador de 1 Interruptor y 4 Vías	Gris	90-277V~50/60Hz	15A	No	24x48x34mm	Acero Inox. + PC + Hierro Galvanizado	IP20	P/Circuito Escalera

# Placas Premium Color Blanco



APL-201

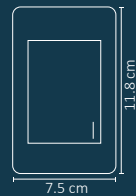

\*Excepto 3 años de APL-207

#	💡	●	⚡	ⓐ	🕒	↔️	💎	💧	🔍
Código	Producto	Color	Voltaje	Corriente Eléctrica	Atenuador	Dimensiones	Material	Protección	Observaciones
APL-201	Interruptor de Circuito Fallo a Tierra GFCI	Blanco	90-277V~50/60Hz	15A	No	75x118mm	Policarbonato + Hierro Galvanizado	IP20	Interruptor 3 Vías

# Placas Premium Color Blanco

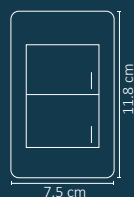
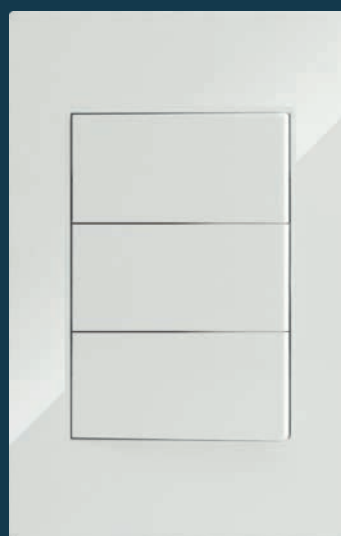
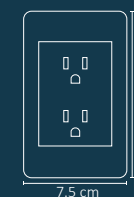
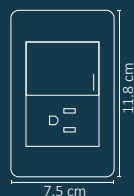
**APL-202**

**APL-203**

**APL-204**

**APL-205**

**APL-206**

**APL-207**

Código	Producto	Color	Voltaje	Corriente Eléctrica	Atenuador	Dimensiones	Material	Protección	Observaciones
APL-202	Placa Apagador de 2 Interruptores y 3 Vías	Blanco	90-277V~50/60Hz	15A	No	75x118mm	Policarbonato + Hierro Galvanizado	IP20	Interruptores 3 Vías
APL-203	Placa Apagador de 3 Interruptores y 3 Vías	Blanco	90-277V~50/60Hz	15A	No	75x118mm	Policarbonato + Hierro Galvanizado	IP20	Interruptores 3 Vías
APL-204	Placa de Contacto Doble	Blanco	90-277V~50/60Hz	15A	No	75x118mm	Policarbonato + Hierro Galvanizado	IP20	2 Contactos
APL-205	Placa de Contacto y Apagador 1 Interruptor 3 Vías	Blanco	90-277V~50/60Hz	15A	No	75x118mm	Policarbonato + Hierro Galvanizado	IP20	Interruptor 3 Vías
APL-206	Placa de Contacto y Apagador 2 Interruptores 3 Vías	Blanco	90-277V~50/60Hz	15A	No	75x118mm	Policarbonato + Hierro Galvanizado	IP20	Interruptores 3 Vías
APL-207	Placa de Contacto y 1 Salidas Usb y TipoC	Blanco	90-277V~50/60Hz	15A	No	75x118mm	Policarbonato + Hierro Galvanizado	IP20	USB/C SALIDA 5V= Máx 2.1A



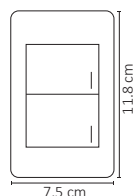
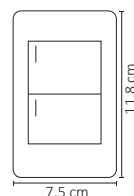
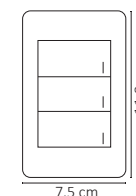
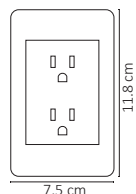
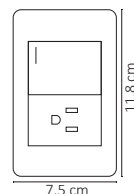
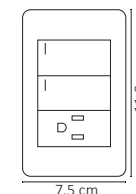

Código	Producto	Color	Voltaje	Corriente Eléctrica	Atenuador	Dimensiones	Material	Protección	Observaciones
APL-208	Placa de Contacto Telefónico	Blanco	N/A	N/A	No	75x118mm	Policarbonato + Hierro Galvanizado	IP20	Conector: RJ11
APL-209	Placa de Contacto Red Lan Tipo RJ45 CAT5	Blanco	N/A	N/A	No	75x118mm	Policarbonato + Hierro Galvanizado	IP20	RJ45 CAT5
APL-210	Placa de Contacto Coaxial para Televisión	Blanco	N/A	N/A	No	75x118mm	Policarbonato + Hierro Galvanizado	IP20	Con Toma TV
APL-211	Placa de Contacto Atenuador Iluminación de 100W	Blanco	100-127V~50/60Hz	0.78A	Si	75x118mm	Policarbonato + Hierro Galvanizado	IP20	Atenuador
APL-212	Placa Tapa Ciega	Blanco	N/A	N/A	No	75x118mm	Policarbonato + Hierro Galvanizado	IP20	Decorativo
APL-213	Placa de Contacto Timbre	Blanco	90-127V~50/60Hz	15A	No	75x118mm	Policarbonato + Hierro Galvanizado	IP20	Timbre

**APL-301**

**APL-302**

**APL-303**

**APL-304**

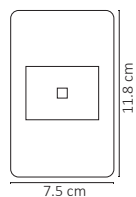
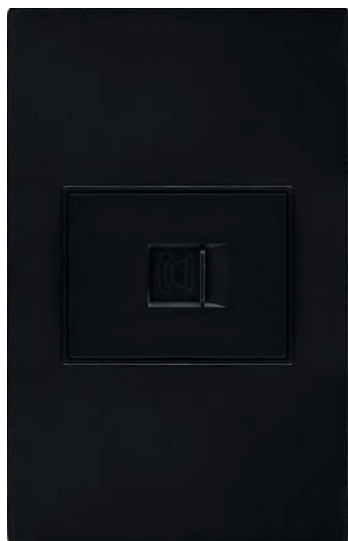
**APL-305**

**APL-306**



Código	Producto	Color	Voltaje	Corriente Eléctrica	Atenuador	Dimensiones	Material	Protección	Observaciones
APL-301	Interruptor de circuito fallo a tierra	Negro	90-277V~50/60Hz	15A	No	75x118mm	Policarbonato + Hierro Galvanizado	IP20	Interruptor 3 Vías
APL-302	Placa Apagador de 2 Interruptores y 3 Vías	Negro	90-277V~50/60Hz	15A	No	75x118mm	Policarbonato + Hierro Galvanizado	IP20	Interruptores 3 Vías
APL-303	Placa Apagador de 3 Interruptores y 3 Vías	Negro	90-277V~50/60Hz	15A	No	75x118mm	Policarbonato + Hierro Galvanizado	IP20	Interruptores 3 Vías
APL-304	Placa de Contacto Doble	Negro	90-277V~50/60Hz	15A	No	75x118mm	Policarbonato + Hierro Galvanizado	IP20	2 Contactos
APL-305	Placa de Contacto y Apagador 1 Interruptor 3 Vías	Negro	90-277V~50/60Hz	15A	No	75x118mm	Policarbonato + Hierro Galvanizado	IP20	Interruptor 3 Vías
APL-306	Placa de Contacto y Apagador 2 Interruptores 3 Vías	Negro	90-277V~50/60Hz	15A	No	75x118mm	Policarbonato + Hierro Galvanizado	IP20	Interruptores 3 Vías



#	💡	●	⚡	ⓐ	🕒	↔	💎	💧	🔍
Código	Producto	Color	Voltaje	Corriente Eléctrica	Atenuador	Dimensiones	Material	Protección	Observaciones
APL-307	Placa de Contacto y 1 Salidas Usb y TipoC	Negro	90-277V~50/60Hz	15A	No	75x118mm	Polycarbonato + Hierro Galvanizado	IP20	USB/C SALIDA 5V= Máx 2.1A

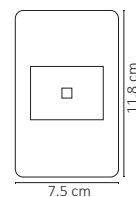

**APL-308**



**APL-309**

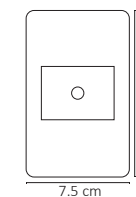
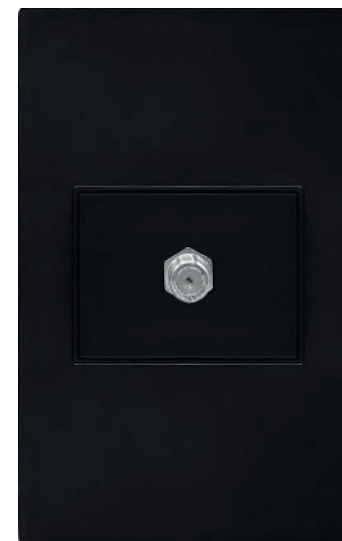

**APL-310**

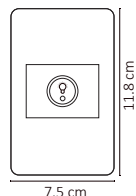

**APL-311**

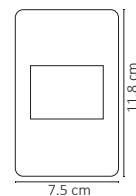
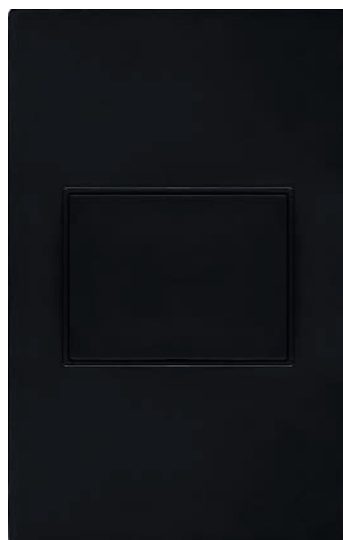

**APL-312**

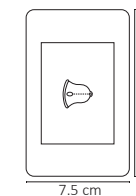

**APL-313**

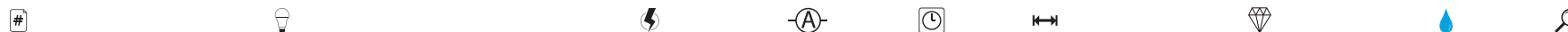

Código	Producto	Color	Voltaje	Corriente Eléctrica	Atenuador	Dimensiones	Material	Protección	Observaciones
APL-308	Placa de Contacto Telefónico	Negro	N/A	N/A	No	75x118mm	Policarbonato + Hierro Galvanizado	IP20	Conector: RJ11
APL-309	Placa de Contacto Red Lan Tipo RJ45 CAT5	Negro	N/A	N/A	No	75x118mm	Policarbonato + Hierro Galvanizado	IP20	RJ45 CAT5
APL-310	Placa de Contacto Coaxial para Televisión	Negro	N/A	N/A	No	75x118mm	Policarbonato + Hierro Galvanizado	IP20	Con Toma TV
APL-311	Placa de Contacto Atenuador Iluminación de 100W	Negro	100-127V~50/60Hz	0.78A	Si	75x118mm	Policarbonato + Hierro Galvanizado	IP20	Atenuador
APL-312	Placa Tapa Ciega	Negro	N/A	N/A	No	75x118mm	Policarbonato + Hierro Galvanizado	IP20	Decorativo
APL-313	Placa de Contacto Timbre	Negro	90-127V~50/60Hz	15A	No	75x118mm	Policarbonato + Hierro Galvanizado	IP20	Timbre





**APL-002**



#	💡	●	⚡	Ⓜ	🕒	📏	💎	💧	🔍
Código	Código	Color	Voltaje	Corriente Eléctrica	Estandar	Dimensiones	Material	Protección	Observaciones
APL-002	Interrupor de Circuito Fallo a Tierra GFCI	Blanco	102-132V~50/60Hz	20A	UL943 / UL498	70x115mm	PC + CU + Acero Galvanizado	IP20	2 Conectores Trifásicos

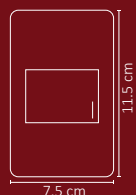

**WPL-301**

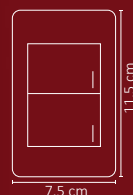

**WPL-302**

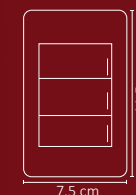

**WPL-303**

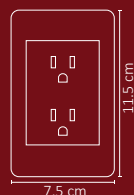

**WPL-304**

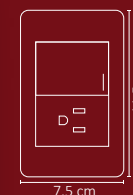

**WPL-305**

#	💡	●	⚡	ⓐ	🕒	↔	💎	💧	🔍
Código	Producto	Color	Voltaje	Corriente Eléctrica	Atenuador	Dimensiones	Material	Protección	Observaciones
WPL-301	Placa Apagador de 1 Interruptores y 3 Vías	Blanco	90-260V~50/60Hz	15A	No	75x115mm	ABS	IP20	Interruptor 3 Vías
WPL-302	Placa Apagador de 3 Interruptores y 3 Vías	Blanco	90-260V~50/60Hz	15A	No	75x115mm	ABS	IP20	Interruptor 3 Vías
WPL-303	Placa de Contacto Doble	Blanco	90-260V~50/60Hz	15A	No	75x115mm	ABS	IP20	2 Contactos
WPL-304	Placa de Contacto y Apagador 1 Interruptor 3 Vías	Blanco	90-260V~50/60Hz	15A	No	75x115mm	ABS	IP20	Interruptor 3 Vías
WPL-305	Placa de Contacto y Apagador 1 Interruptor 3 Vías	Blanco	90-260V~50/60Hz	15A	No	75x115mm	ABS	IP20	Interruptor 3 Vías



Sálida  
USB

Tipo  
C

WPL-307



USB



Tipo C

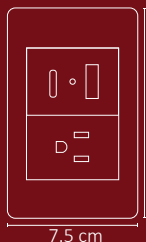

- # Código: WPL-307
- 💡 Producto: Placa de Contacto, Una Salida USB y Tipo C
- Color: Blanco
- ⚡ Voltaje: 90-260~50/60Hz
- ⓐ Corriente eléctrica: 15A
- 🕒 Atenuador: No
- 📏 Dimensiones: 75x115mm
- 💎 Material: ABS
- 💧 Protección: IP20
- 🔍 Observaciones: USB/C SÁLIDA 5V= Máx. 2.1A



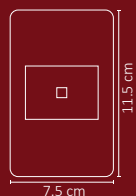

**WPL-308**

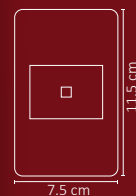

**WPL-309**

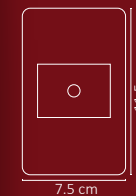

**WPL-310**



**WPL-311**



**WPL-312**

Código	Producto	Color	Voltaje	Corriente Eléctrica	Atenuador	Dimensiones	Material	Protección	Observaciones
WPL-308	Placa de Contacto Telefónico	Blanco	N/A	N/A	No	75x115mm	ABS	IP20	Contacto Telefónico
WPL-309	Placa de Contacto Red Lan Tipo RJ45 CAT5	Blanco	N/A	N/A	No	75x115mm	ABS	IP20	RJ45 CAT5
WPL-310	Placa de Contacto Coaxial para Televisión	Blanco	N/A	N/A	No	75x115mm	ABS	IP20	Con Toma TV
WPL-311	Placa de Contacto Atenuador Iluminación de 100W	Blanco	100-127V~50/60Hz	0.78A	Si	75x115mm	ABS	IP20	Atenuador
WPL-312	Placa Tapa Ciega	Blanco	N/A	N/A	No	75x115mm	ABS	IP20	Decorativo





WPL-313

Timbre

- # Código: WPL-313
- 💡 Producto: Placa Contacto Timbre
- Color: Blanco
- ⚡ Voltaje: 90-127V~50/60Hz
- Ⓜ Corriente eléctrica: 15A
- ↔ Dimensiones: 75x115mm
- 💎 Material: ABS
- 💧 Protección: IP20

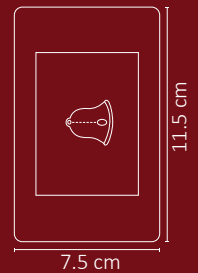

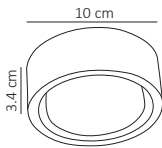

WDE-001

WDE-002

6W

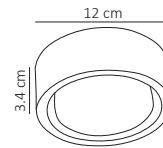

WDE-003

WDE-004

12W

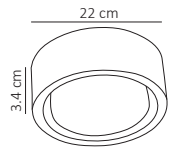

WDO-005

WDO-006

18W



Código	Producto	Watts	Voltaje	Lúmenes	Apertura	Temp. Color	Dimensiones	Material	Protección	Observaciones
WDE-001	Luminaria Sobreponer Techo Circular Metal Negro BF	6W	90-260V~50/60Hz	1,100LM	240°	6500K	D. 100x34mm	Policarbonato	IP20	Sobreponer / Fácil Instalación
WDE-002	Luminaria Sobreponer Techo Circular Metal Negro BC	6W	90-260V~50/60Hz	1,000LM	240°	3000K	D. 100x34mm	Policarbonato	IP20	Sobreponer / Fácil Instalación
WDE-003	Luminaria Sobreponer Techo Circular Metal Negro BF	12W	90-260V~50/60Hz	1,950LM	240°	6500K	D. 120x34mm	Policarbonato	IP20	Sobreponer / Fácil Instalación
WDE-004	Luminaria Sobreponer Techo Circular Metal Negro BC	12W	90-260V~50/60Hz	1,800LM	240°	3000K	D. 120x34mm	Policarbonato	IP20	Sobreponer / Fácil Instalación
WDE-005	Luminaria Sobreponer Techo Circular Metal Negro BF	18W	90-260V~50/60Hz	3,950LM	240°	6500K	D. 220x34mm	Policarbonato	IP20	Sobreponer / Fácil Instalación
WDE-006	Luminaria Sobreponer Techo Circular Metal Negro BC	18W	90-260V~50/60Hz	3,600LM	240°	3000K	D. 220x34mm	Policarbonato	IP20	Sobreponer / Fácil Instalación



12W



18W



#	💡	Ⓜ	⚡	☀️	360°	🌈	↔️	💎	💧	🔍
Código	Producto	Watts	Voltaje	Lúmenes	Apertura	Temp. Color	Dimensiones	Material	Prot	Observaciones
WDE-007	Luminaria LED Pared Nautica Blanco PC Blanco Frío	12W	90-260V~50/60Hz	850LM	120°	6500K	177x85x55mm	Plástico	IP20	Fácil Instalación
WDE-008	Luminaria LED Pared Nautica Blanco PC Blanco Cálido	12W	90-260V~50/60Hz	840LM	120°	3000K	177x85x55mm	Plástico	IP20	Fácil Instalación
WDE-009	Luminaria LED Pared Nautica Blanco PC Blanco Frío	18W	90-260V~50/60Hz	1260LM	120°	6500K	200x100x54mm	Plástico	IP20	Fácil Instalación
WDE-010	Luminaria LED Pared Nautica Blanco PC Blanco Cálido	18W	90-260V~50/60Hz	1250LM	120°	3000K	200x100x54mm	Plastico	IP20	Fácil Instalación



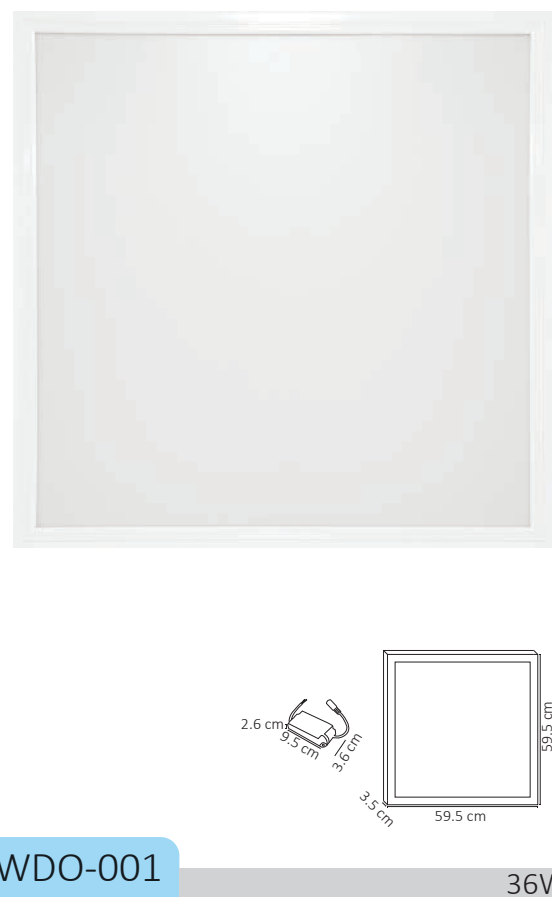

Código	Producto	Watts	Voltaje	Lúmenes	Apertura	Temp. Color	Dimensiones	Material	Protección	Observaciones
WDO-002	Pánel LED Redondo 5W Blanco Frío	5W	90-260V~50/60Hz	380LM	120°	6500K	D. 95x33mm	Plástico + Policarbonato	IP20	Diam. Emp. 8.5cm/Incluye driver
WDO-005	Pánel LED Redondo 5W Blanco Cálido	5W	90-260V~50/60Hz	330LM	120°	3000K	D. 95x33mm	Plástico + Policarbonato	IP20	Diam. Emp. 8.5cm/Incluye driver
WDO-003	Pánel LED Redondo 12W Blanco Frío	12W	90-260V~50/60Hz	900LM	120°	6500K	D. 138x40mm	Plástico + Policarbonato	IP20	Diam. Emp. 12cm/Incluye driver
WDO-006	Pánel LED Redondo 12W Blanco Cálido	12W	90-260V~50/60Hz	850LM	120°	3000K	D. 138x40mm	Plástico + Policarbonato	IP20	Diam. Emp. 12cm/Incluye driver
WDO-001	Pánel LED Cuadrado Empotrable Blanco Frío	36W	90-260V~50/60Hz	3,000LM	120°	6500K	595x595x35mm	Aluminio + Policarbonato	IP20	Incluye driver y sujetadores
WDO-004	Pánel LED Rectangular Empotrable Blanco Frío	72W	90-260V~50/60Hz	6,000LM	120°	6500K	1195x595x35mm	Aluminio + Policarbonato	IP20	Incluye driver y sujetadores



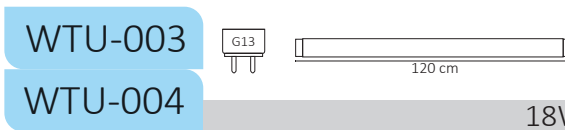
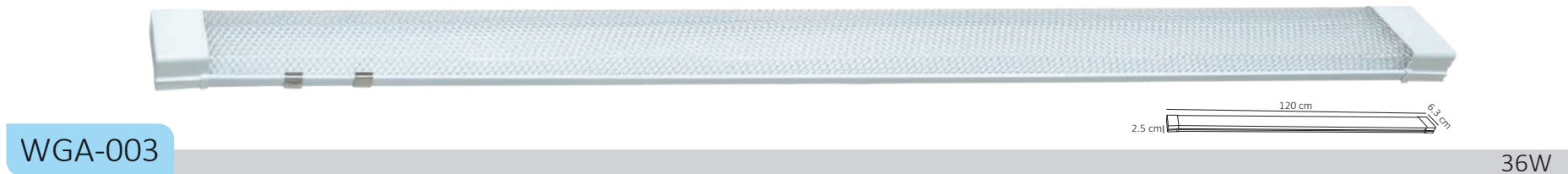

Código	Producto	Watts	Voltaje	Lúmenes	Apertura	Temp. Color	Dimensiones	Material	Protección	Observaciones
WGA-001	Gabinete Canaleta Doble T8 120cm	Máx. 50W	90-260V~50/60Hz	-	-	-	1217x77x40mm	Metal	IP20	P/2 Tubos T8 G13/ No Incluye Tubos
WGA-002	Gabinete Canaleta 1xT8 120cm	Máx. 50W	90-260V~50/60Hz	-	-	-	1217x57x40mm	Metal	IP20	P/1 Tubo T8 G13/ No Incluye Tubo
WGA-003	Gabinete Slim LED Integrado Tipo Regleta Escolar	36W	90-260V~50/60Hz	3,600LM	120°	6500K	1200x63x25mm	Polycarbonato	IP20	Sobreponer/ LED Integrado
WTU-006	Tubo LED Base de Plástico Transparente Blanco Frío	9W	90-260V~50/60Hz	800LM	120°	6500K	600x30mm	Vidrio + Plástico	IP20	Con Base
WTU-005	Tubo LED Base de Plástico Transparente Blanco Frío	18W	90-260V~50/60Hz	1,600LM	120°	6500K	1200x30mm	Vidrio + Plástico	IP20	Con Base
WTU-003	Tubo LED Vidrio Transparente Blanco Frío	18W	90-260V~50/60Hz	1,750LM	120°	6500K	1200x26mm	Vidrio + Plástico	IP20	Conexión 2 Polos
WTU-004	Tubo LED Vidrio Opalino Blanco Frío	18W	90-260V~50/60Hz	1,700LM	150°	6500K	1200x26mm	Vidrio Opalino + Plástico	IP20	Conexión 2 Polos
WTU-007	Tubo LED -1 PIN- Transparente T8 Blanco Frío	36W	90-260V~50/60Hz	3,000LM	120°	6500K	2400x30mm	Vidrio + Plástico	IP20	Incluye Aro Sujetador

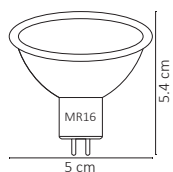

WLA-012

WLA-013

3W

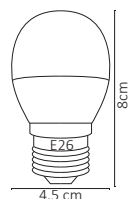

WLA-006

WLA-007

3W

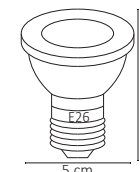

WLA-005

3W

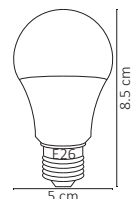

WLA-001

WLA-008

5W

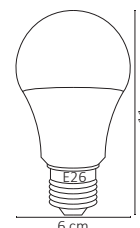

WLA-002

WLA-009

10W

#	💡	Ⓜ	⚡	☀️	360°	🌈	📏	💎	💧	🔍
Código	Producto	Watts	Voltaje	Lúmenes	Apertura	Temp. Color	Dimensiones	Material	Protección	Observaciones
WLA-012	Lámpara LED Spot MR16 Blanco Frío	3W	100-140V~50/60Hz	270LM	120°	6500K	50x55mm	Plástico	IP20	MR16
WLA-013	Lámpara LED Spot MR16 Blanco Cálido	3W	100-140V~50/60Hz	250LM	120°	3000K	50x55mm	Plástico	IP20	MR16
WLA-006	Lámpara LED Bulbo E26 Blanco Frío	3W	100-140V~50/60Hz	250LM	220°	6500K	45x80mm	Aluminio + Plástico + PC	IP20	E26
WLA-007	Lámpara LED Bulbo E26 Blanco Cálido	3W	100-140V~50/60Hz	230LM	220°	3000K	45x80mm	Aluminio + Plástico + PC	IP20	E26
WLA-005	Lámpara LED Spot E26 RGB	3W	90-260V~50/60Hz	200LM	30°	Multicolor	50x65mm	Aluminio + Plástico	IP20	E26 / Incluye Control
WLA-001	Lámpara LED Bulbo E26 Blanco Frío	5W	100-140V~50/60Hz	430LM	220°	6500K	50x85mm	Aluminio + Plástico + PC	IP20	E26
WLA-008	Lámpara LED Bulbo E26 Blanco Cálido	5W	100-140V~50/60Hz	400LM	220°	3000K	50x85mm	Aluminio + Plástico + PC	IP20	E26
WLA-002	Lámpara LED Bulbo E26 Blanco Frío	10W	100-140V~50/60Hz	850LM	220°	6500K	60x110mm	Aluminio + Plástico + PC	IP20	E26
WLA-009	Lámpara LED Bulbo E26 Blanco Cálido	10W	100-140V~50/60Hz	800LM	220°	3000K	60x110mm	Aluminio + Plástico + PC	IP20	E26

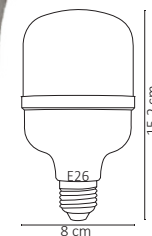
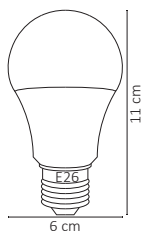

WLA-014

WLA-015

3 de 10W

WLA-010

20W

#	💡	W	⚡	☀️	360°	🌈	↔️	💎	💧	🔍
Código	Producto	Watts	Voltaje	Lúmenes	Apertura	Temp. Color	Dimensiones	Material	Protección	Observaciones
WLA-014	Foco Lámpara 3 Pack LED Bulbo E26 10W Blanco Frío	3 x 10W	100-140V~50/60Hz	850LM	220°	6500K	60x110mm	Aluminio + Plástico + PC	IP20	Incluye 3 Lámparas
WLA-015	Foco Lámpara 3 Pack LED Bulbo E26 10W Blanco Cálido	3 x 10W	100-140V~50/60Hz	800LM	220°	3000K	60x110mm	Aluminio + Plástico + PC	IP20	Incluye 3 Lámparas
WLA-010	Lámpara Industrial LED E26 Blanco Frío	20W	90-260V~50/60Hz	1,700LM	150°	6500K	80x152mm	Aluminio + Policarbonato	IP20	Base E26



WRE-004

10W



WRE-006

50W

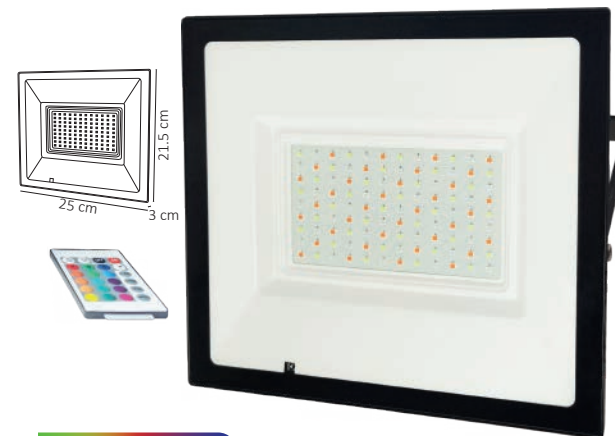

WRE-015

100W

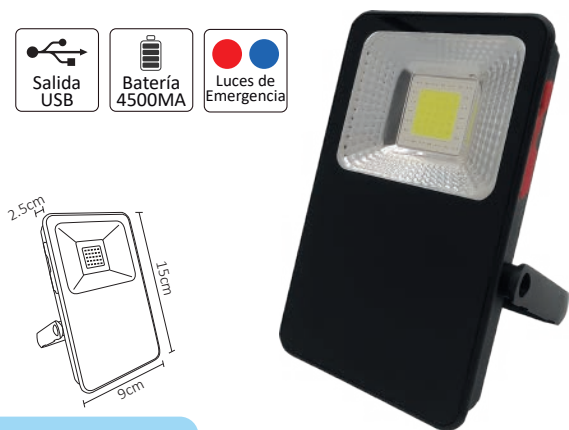

WRE-011

10W

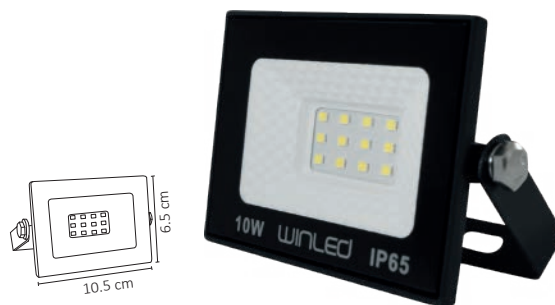

WRE-008

10W

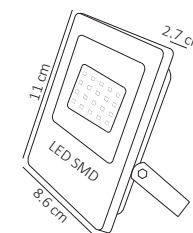

WRE-009

20W



Código	Producto	Watts	Voltaje	Lúmenes	Apertura	Temp. Color	Dimensiones	Material	Protección	Observaciones
WRE-004	Reflector LED 10W SMD RGB con Control Remoto	10W	90-260V~50/60Hz	Máx. 700LM	220°	Multicolor	90x70x28mm	Aluminio + Vidrio	IP65	Incluye Control
WRE-006	Reflector LED 50W SMD RGB con Control Remoto	50W	90-260V~50/60Hz	Máx 3,000LM	220°	Multicolor	178x150x28mm	Aluminio + Vidrio	IP65	Incluye Control
WRE-015	Reflector LED 100W SMD RGB con Control Remoto	100W	90-260V~50/60Hz	Máx 6,000LM	220°	Multicolor	250x215x30mm	Aluminio + Vidrio	IP65	Incluye Control
WRE-011	Reflector SMD Portátil Recargable USB	10W	90-260V~50/60Hz	Máx. 800LM	120°	6500K	150x90x25mm	Plástico + Vidrio	IP54	Batería Portátil y USB. Cambio de Intensidad y Colores (Azul y Rojo)
WRE-008	Reflector LED SMD Cuadrado Blanco Frío Exterior	10W	90-260V~50/60Hz	850LM	120°	6500K	105x65x25mm	Aluminio + Vidrio	IP65	Fácil Instalación
WRE-009	Reflector LED SMD Cuadrado Blanco Frío Exterior	20W	90-260V~50/60Hz	1700LM	120°	6500K	86x110x27mm	Aluminio + Vidrio	IP65	Fácil Instalación



# Reflectores y Campanas LED

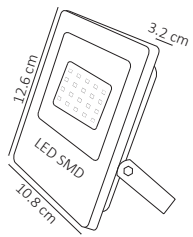

WRE-012

30W

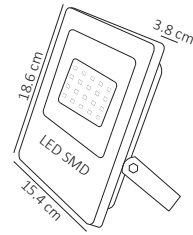

WRE-013

50W

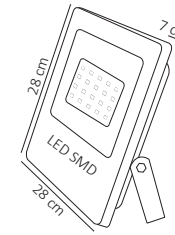

WRE-014

100W

120  
LM/W  
EFICIENCIA

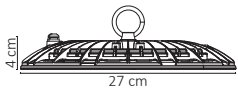

WRE-007

100W

120  
LM/W  
EFICIENCIA

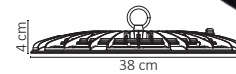

WRE-010

200W

#	💡	Ⓜ	⚡	☀️	360°	🌈	↔️	💎	💧	🔍
Código	Producto	Watts	Voltaje	Lúmenes	Apertura	Temp. Color	Dimensiones	Material	Protección	Observaciones
WRE-012	Reflector LED SMD Cuadrado Blanco Frío Exterior	30W	90-260V~50/60Hz	2,550LM	120°	6500K	108x126x32mm	Aluminio + Vidrio	IP65	Fácil Instalación
WRE-013	Reflector LED SMD Cuadrado Blanco Frío Exterior	50W	90-260V~50/60Hz	4,250LM	120°	6500K	154x186x38mm	Aluminio + Vidrio	IP65	Fácil Instalación
WRE-014	Reflector LED SMD Cuadrado Blanco Frío Exterior	100W	90-260V~50/60Hz	9,000LM	120°	6500K	280x280x70mm	Aluminio + Vidrio	IP65	Fácil Instalación
WRE-007	Campana LED Slim Grafeno Multivoltaje Exterior	100W	90-277V~50/60Hz	12,000LM	90°	6500K	D. 270x40mm	Aluminio + PC	IP66	Fácil Instalación
WRE-010	Campana LED Slim Grafeno Multivoltaje Exterior	180W	90-277V~50/60Hz	24,000LM	90°	6500K	D. 380x40mm	Aluminio + PC	IP66	Fácil Instalación



ATENUABLE 0-10V  
 12V  
 5m LONGITUD DE TIRA  
 18 cm

WTI-001

36W



ATENUABLE 0-10V  
 12V  
 5m LONGITUD DE TIRA  
 18 cm

WTI-002

72W



ATENUABLE 0-10V  
 12V  
 5m LONGITUD DE TIRA  
 18 cm

WTI-012

72W



ATENUABLE 0-10V  
 12V  
 5m LONGITUD DE TIRA  
 18 cm

WTI-003

WTI-004

72W



ATENUABLE 0-10V  
 12V  
 5m LONGITUD DE TIRA  
 18 cm

WTI-005

24W



ATENUABLE 0-10V  
 12V  
 5m LONGITUD DE TIRA  
 18 cm

WTI-006

WTI-007

24W

#	💡	W	⚡	☀️	360°	🌈	↔️	💎	💧	🔍
Código	Producto	Watts	Voltaje	Lúmenes	Apertura	Temp. Color	Dimensiones	Material	Protección	Observaciones
WTI-001	Tira 150 LEDs 5050 Exterior RGB	36W	12V==	900-1,800LM	120°	Multicolor	5000x10x2mm	Cubierta de Silicón	IP65	*Atenuable / Corte cada 3 leds
WTI-002	Tira 300 LEDs 5050 Exterior RGB	72W	12V==	700-3,500LM	120°	Multicolor	5000x10x2mm	Cubierta de Silicón	IP65	*Atenuable / Corte cada 3 leds
WTI-012	Tira 300 LEDs 5050 Interior Blanco Frío	72W	12V==	3,600LM	120°	6500K	5000x10x2mm	Tira Flexible Adhesiva	IP20	*Atenuable / Sin Recubrimiento
WTI-003	Tira 300 LEDs 5050 Exterior Blanco Frío	72W	12V==	3,600LM	120°	6500K	5000x10x2mm	Cubierta de Silicón	IP65	*Atenuable / Corte cada 3 leds
WTI-004	Tira 300 LEDs 5050 Exterior Blanco Cálido	72W	12V==	3,400LM	120°	3000K	5000x10x2mm	Cubierta de Silicón	IP65	*Atenuable / Corte cada 3 leds
WTI-005	Tira 300 LEDs 2835 Interior Blanco Frío	24W	12V==	1,300LM	120°	6500K	5000x10x2mm	Tira Flexible Adhesiva	IP20	*Atenuable / Sin Recubrimiento
WTI-006	Tira 300 LEDs 2835 Exterior Blanco Frío	24W	12V==	1,300LM	120°	6500K	5000x10x2mm	Cubierta de Silicón	IP65	*Atenuable / Corte cada 3 leds
WTI-007	Tira 300 LEDs 2835 Exterior Blanco Cálido	24W	12V==	1,250LM	120°	3000K	5000x10x2mm	Cubierta de Silicón	IP65	*Atenuable / Corte cada 3 leds

\*Requiere un dimmer compatible de corriente directa para atenuar las tiras.

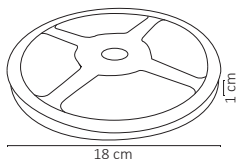

WTI-008

24W

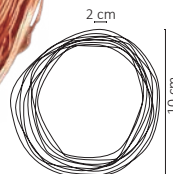

WTI-016

WTI-017

2W

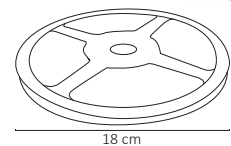

WTI-013

WTI-014

WTI-015

50W

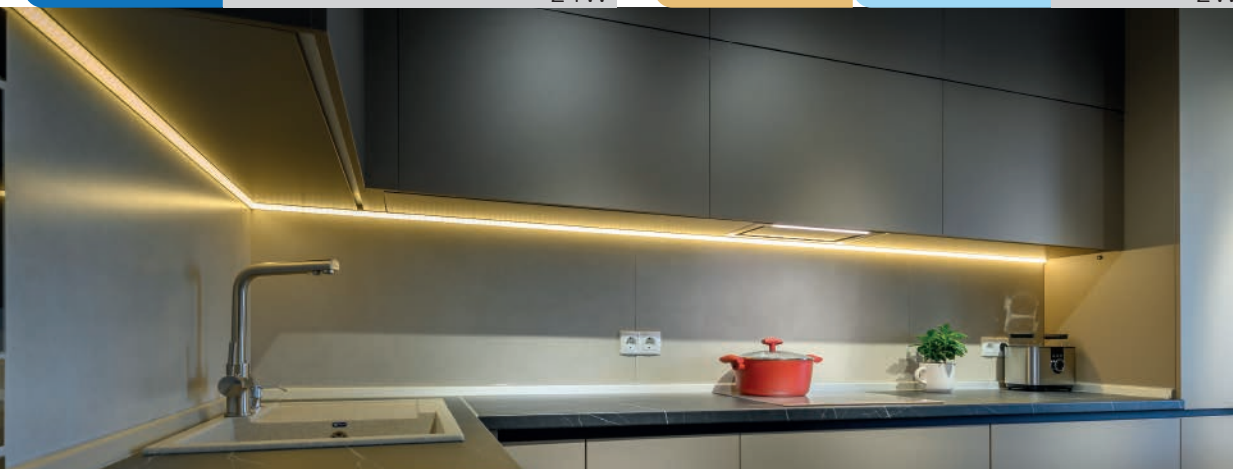

#	💡	Ⓜ	⚡	☀️	360°	🌈	↔️	💎	💧	🔍
Código	Producto	Watts	Voltaje	Lúmenes	Apertura	Temp. Color	Dimensiones	Material	Protección	Observaciones
WTI-008	Tira 300 LEDs 2835 5M 24W Exterior Azul	24W	12V===	280LM	120°	Azul	5000x8x2mm	Cubierta de Silicón	IP65	*Atenuable / Corte cada 3 leds
WTI-016	Tira LED Arroz 10M 2W Exterior Blanco Cálido	2W	12V===	130LM	120°	3000K	10000x3mm	Cable de Cobre + Silicón	IP65	12 Volts CD / *Atenuable
WTI-017	Tira LED Arroz 10M 2W Exterior Blanco Frío	2W	12V===	130LM	120°	6500K	10000x3mm	Cable de Cobre + Silicón	IP65	12 Volts CD / *Atenuable
WTI-013	Tira LED COB Continuo 5M 50W Blanco Cálido	50W	24V===	4,000LM	120°	3000K	5000x10mm	Tira Flexible Adhesiva	IP20	24 Volts CD / *Atenuable
WTI-014	Tira LED COB Continuo 5M 50W Blanco Neutro	50W	24V===	4,150LM	120°	4000K	5000x10mm	Tira Flexible Adhesiva	IP20	24 Volts CD / *Atenuable
WTI-015	Tira LED COB Continuo 5M 50W Blanco Frío	50W	24V===	4,250LM	120°	6500K	5000x10mm	Tira Flexible Adhesiva	IP20	24 Volts CD / *Atenuable

\*Requiere un dimmer compatible de corriente directa para atenuar las tiras.





ATENUABLE

**10**  
METROS  
POR ROLLO

**60**  
LED/M  
2835

5 cm

25 cm

**WMA-012** **WMA-013**

40W

ATENUABLE

**25**  
METROS  
POR ROLLO

**60**  
LED/M  
2835

8 cm

25 cm

**WMA-006** **WMA-007**

100W

ATENUABLE

**25**  
METROS  
POR ROLLO

**60**  
LED/M  
2835

8 cm

25 cm

**WMA-008** **WMA-009**

**WMA-010** **WMA-011**

100W

ATENUABLE

**25**  
METROS  
POR ROLLO

**120**  
LED/M  
2835

8 cm

25 cm

**WMA-014** **WMA-015**

150W

#	💡	W	⚡	☀️	360°	🌈	📏	💎	💧	🔍
Código	Producto	Watts	Voltaje	Lúmenes	Apertura	Temp. Color	Dimensiones	Material	Protección	Observaciones
WMA-012	Manguera LED 2835 10m Exterior Blanco Frío	40W	127V~50/60Hz	2,800LM	120°	6500K	10000x11x6.5mm	Silicón	IP65	Se Puede Cortar Cada 1 Metro
WMA-013	Manguera LED 2835 10m Exterior Blanco Cálido	40W	127V~50/60Hz	2,720LM	120°	3000K	10000x11x6.5mm	Silicón	IP65	Se Puede Cortar Cada 1 Metro
WMA-006	Manguera LED 2835 25m Exterior Blanco Frío	100W	127V~50/60Hz	7,000LM	120°	6500K	25000x11x6.5mm	Silicón	IP65	Se Puede Cortar Cada 1 Metro
WMA-007	Manguera LED 2835 25m Exterior Blanco Cálido	100W	127V~50/60Hz	6,800LM	120°	3000K	25000x11x6.5mm	Silicón	IP65	Se Puede Cortar Cada 1 Metro
WMA-008	Manguera LED 2835 25m Exterior Azul	100W	127V~50/60Hz	1,750LM	120°	Azul	25000x11x6.5mm	Silicón	IP65	Se Puede Cortar Cada 1 Metro
WMA-009	Manguera LED 2835 25m Exterior Rojo	100W	127V~50/60Hz	2,300LM	120°	Rojo	25000x11x6.5mm	Silicón	IP65	Se Puede Cortar Cada 1 Metro
WMA-010	Manguera LED 2835 25m Exterior Verde	100W	127V~50/60Hz	3,500LM	120°	Verde	25000x11x6.5mm	Silicón	IP65	Se Puede Cortar Cada 1 Metro
WMA-011	Manguera LED 2835 25m Exterior Amarillo	100W	127V~50/60Hz	3,500LM	120°	Amarillo	25000x11x6.5mm	Silicón	IP65	Se Puede Cortar Cada 1 Metro
WMA-014	Manguera Doble LED 2835 25m Blanco Frío	150W	127V~50/60Hz	10,500LM	120°	6500K	25000x11x6.5mm	Silicón	IP65	Se Puede Cortar Cada 1 Metro
WMA-015	Manguera Doble LED 2835 25m Blanco Cálido	150W	127V~50/60Hz	10,500LM	120°	3000K	25000x11x6.5mm	Silicón	IP65	Se Puede Cortar Cada 1 Metro

\*Para atenuar las mangueras LED se requiere el accesorio WAC-016 (se vende por separado).





\*Colores de mangueras simulando el color de luz.

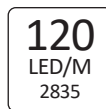
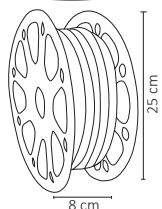

WMA-016

WMA-017

WMA-018

WMA-019

WMA-020

150W

#	💡	Ⓜ	⚡	☀️	360°	🌈	📏	💎	💧	🔍
Código	Producto	Watts	Voltaje	Lúmenes	Apertura	Temp. Color	Dimensiones	Material	Protección	Observaciones
WMA-016	Manguera Neón Doble LED 2835 25m Blanco Frío	150W	127V~50/60Hz	10,500LM	150°	6500K	25000x9x14mm	Silicón	IP65	Neón / Corte Cada 50cm.
WMA-017	Manguera Neón Doble LED 2835 25m Blanco Cálido	150W	127V~50/60Hz	10000LM	150°	3000K	25000x9x14mm	Silicón	IP65	Neón / Corte Cada 50cm.
WMA-018	Manguera Neón Doble LED 2835 25m Verde	150W	127V~50/60Hz	5,250LM	150°	Verde	25000x9x14mm	Silicón	IP65	Neón / Corte Cada 50cm.
WMA-019	Manguera Neón Doble LED 2835 25m Azul	150W	127V~50/60Hz	2,250LM	150°	Azul	25000x9x14mm	Silicón	IP65	Neón / Corte Cada 50cm.
WMA-020	Manguera Neón Doble LED 2835 25m Rojo	150W	127V~50/60Hz	2,250LM	150°	Rojo	25000x9x14mm	Silicón	IP65	Neón / Corte Cada 50cm.

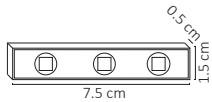

**WMO-001**

0.72W

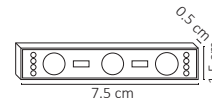

**WMO-008**

**WMO-009**

0.72W

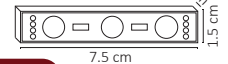

**WMO-010**

**WMO-011**

**WMO-012**

**WMO-013**

0.72W

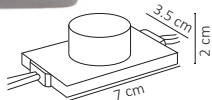

**WMO-014**

**WMO-015**

**WMO-016**

1.4W

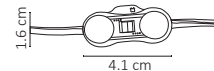

**WMO-017**

**WMO-018**

**WMO-019**

1W

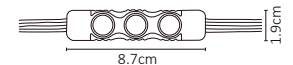

**WMO-020**

**WMO-021**

1.6W

#	💡	Ⓜ	⚡	☀️	360°	🌈	↔️	💎	💧	🔍
Código	Producto	Watts	Voltaje	Lúmenes	Apertura	Temp. Color	Dimensiones	Material	Protección	Observaciones
WMO-001	Módulo 3 LEDs SMD 5050 Exterior RGB	0.72W	12V=	15-40LM	120°	Multicolor	75x15x5mm	Plástico + Policarbonato	IP65	RGB
WMO-008	Módulo 3 LEDs SMD 2835 Exterior Blanco Frío	0.72W	12V=	60LM	120°	6500K	75x15x5mm	Plástico + Policarbonato	IP65	Blanco Frío
WMO-009	Módulo 3 LEDs SMD 2835 Exterior Blanco Cálido	0.72W	12V=	55LM	120°	3000K	75x15x5mm	Plástico + Policarbonato	IP65	Blanco Cálido
WMO-010	Módulo 3 LEDs SMD 2835 Exterior Azul	0.72W	12V=	15LM	120°	Azul	75x15x5mm	Plástico + Policarbonato	IP65	Azul
WMO-011	Módulo 3 LEDs SMD 2835 Exterior Rojo	0.72W	12V=	20LM	120°	Rojo	75x15x5mm	Plástico + Policarbonato	IP65	Rojo
WMO-012	Módulo 3 LEDs SMD 2835 Exterior Verde	0.72W	12V=	30LM	120°	Verde	75x15x5mm	Plástico + Policarbonato	IP65	Verde
WMO-013	Módulo 3 LEDs SMD 2835 Exterior Amarillo	0.72W	12V=	30LM	120°	Amarillo	75x15x5mm	Plástico + Policarbonato	IP65	Amarillo
WMO-014	Módulo Super LED con Óptica Exterior Blanco Frío	1.4W	12V=	130LM	120°	6500K	70x35x20mm	Plástico + Policarbonato	IP65	Blanco Frío
WMO-015	Módulo Super LED con Óptica Exterior Azul	1.4W	12V=	25LM	120°	Azul	70x35x20mm	Plástico + Policarbonato	IP65	Azul
WMO-016	Módulo Super LED con Óptica Exterior Rojo	1.4W	12V=	30LM	120°	Rojo	70x35x20mm	Plástico + Policarbonato	IP65	Rojo
WMO-017	Módulo LED x2 Samsung SMD 2835 Blanco Cálido	1W	12V=	100LM	120°	3000K	16x41mm	Plástico + Policarbonato	IP67	Blanco Cálido
WMO-018	Módulo LED x2 Samsung SMD 2835 Blanco Neutro	1W	12V=	100LM	150°	4000K	16x41mm	Plástico + Policarbonato	IP67	Blanco Neutro
WMO-019	Módulo LED x2 Samsung SMD 2835 Blanco Frío	1W	12V=	100LM	150°	6500K	16x41mm	Plástico + Policarbonato	IP67	Blanco Frío
WMO-020	Módulo LED 3xSMD 2835 Blanco Frío	1.6W	100-135V~50/60Hz	115LM	150°	6500K	87x19x9mm	Plástico + Policarbonato	IP67	Trabajan de 2 en 2
WMO-021	Módulo LED 3xSMD 2835 Blanco Cálido	1.6W	100-135V~50/60Hz	115LM	120°	3000K	87x19x9mm	Plástico + Policarbonato	IP67	Trabajan de 2 en 2



12V  
80%  
Eficiencia

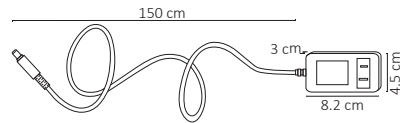

WEL-001

24W



12V  
80%  
Eficiencia

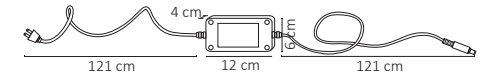

WEL-002

60W



12V

90%  
Eficiencia

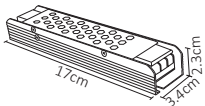

WEL-005

60W



12V

90%  
Eficiencia

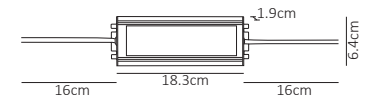

WEL-006

100W

#	💡	W	⚡	🔌	⚙️	📏	💎	💧	🔍
Código	Producto	Watts	Voltaje	Voltaje de Salida	Eficiencia	Dimensiones	Material	Protección	Observaciones
WEL-001	Eliminador de Voltaje CD 12V a 2A Interior	24W	90-260V~50/60Hz	12V	80%	82x45x30mm	Plástico	IP20	Med. del Cable: 150cm
WEL-002	Eliminador de Voltaje CD 12V a 5A Interior	60W	90-260V~50/60Hz	12V	80%	120x60x40mm	Plástico	IP20	Med. de los Cables: 121cm c/u
WEL-005	Fuente de Poder CD 12V a 5A Aluminio Interior	60W	90-260V~50/60Hz	12V	90%	170x34x23mm	Aluminio	IP20	Compatible con Tiras 12V CD
WEL-006	Fuente de Poder CD 12V a 8.3A Aluminio Resistente	100W	90-260V~50/60Hz	12V	90%	183x64x19mm	Aluminio	IP67	Med. de los Cables 16cm c/u



90%  
Eficiencia

IP63  
A Prueba de Lluvias

12V

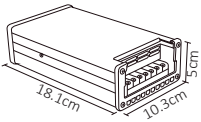

WEL-007

200W

90%  
Eficiencia

IP63  
A Prueba de Lluvias

12V

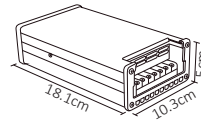

WEL-008

350W

24V

90%  
Eficiencia

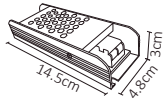

WEL-011

100W

12V

90%  
Eficiencia

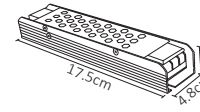

WEL-012

150W

#	💡	Ⓜ	⚡	🔌	⚙️	📏	💎	💧	🔍
Código	Producto	Watts	Voltaje	Voltaje de Salida	Eficiencia	Dimensiones	Material	Protección	Observaciones
WEL-007	Fuente de Poder CD 12V a 16.7A Aluminio Impermeable	200W	90-140V~50/60Hz	12V ===	90%	181x103x50mm	Alum. Impermeable	IP63	A prueba de Lluvias
WEL-008	Fuente de Poder CD 12V a 16.7A Aluminio Impermeable	200W	90-140V~50/60Hz	12V ===	90%	181x103x50mm	Alum. Impermeable	IP63	A Prueba de Lluvias
WEL-011	Fuente de Poder CD 12V a 29.16A Aluminio Impermeable	350W	90-140V~50/60Hz	12V ===	90%	181x103x50mm	Alum. Impermeable	IP63	Compatible con WTI-013/014/015
WEL-012	Fuente de Poder CD 12V a 29.16A Aluminio Impermeable	150W	90-260V~50/60Hz	12V ===	90%	175x48x29mm	Aluminio	IP20	Para Interiores / Para Tiras de 12V



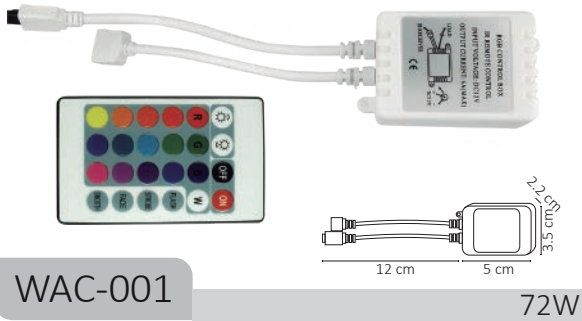

**WAC-001**

72W

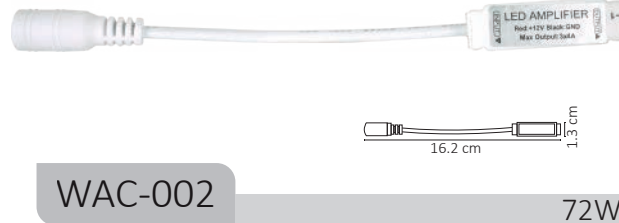

**WAC-002**

72W

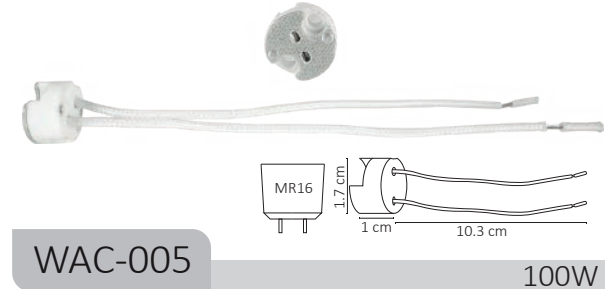

**WAC-005**

100W



**WAC-006**

100W



**WAC-007**

100W



**WAC-012**

100W

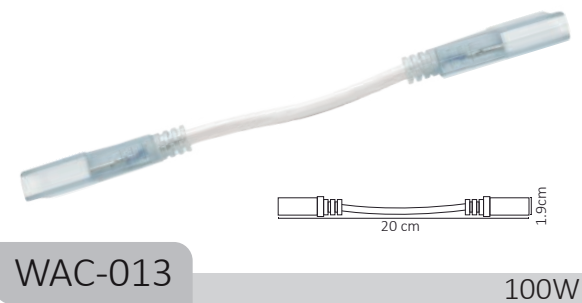

**WAC-013**

100W

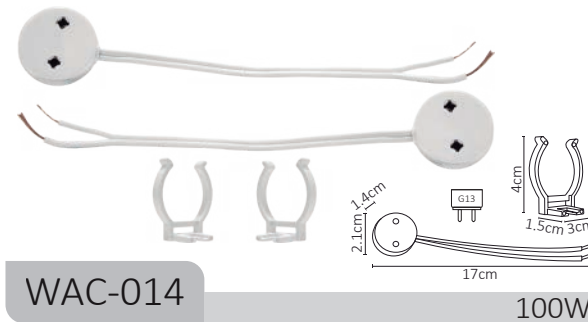

**WAC-014**

100W



**WAC-015**

#	💡	Ⓜ	⚡	☀️	360°	🌈	↔️	💎	💧	🔍
Código	Producto	Watts	Voltaje	Lúmenes	Apertura	Temp. Color	Dimensiones	Material	Protección	Observaciones
WAC-001	Controlador Tira RGB con Control de 16 Colores	72W	12V===	-	-	-	50x35x22mm	Plástico	IP20	Incluye Control con Batería
WAC-002	Amplificador Tira RGB Slim Interior	72W	12V===	-	-	-	162x13mm	Plástico	IP20	Amplificador
WAC-005	Conector Base MR16 Plástico con Cable	100W	90-260V~50/60Hz	-	-	-	17x10mm	Cerámica	IP20	Medida del Cable: 10.3cm
WAC-006	Conector Base GU10 Cerámica con Cable	100W	90-260V~50/60Hz	-	-	-	28x16mm	Cerámica	IP20	Medida del Cable: 7.2cm
WAC-007	Conector Base G13 para Tubo T8	100W	90-260V~50/60Hz	-	-	-	38x38mm	Plástico	IP20	Base para Tubo G13
WAC-012	Conector Simple Kit para 50M Manguera 2835 CA 127V Exterior	Max. 200W	127V~50/60Hz	-	-	-	470x33mm	Plástico	IP65	Para Conectar Manguera 127V
WAC-013	Conector Extensión Manguera 2835 20cm Exterior	100W	127V~50/60Hz	-	-	-	200x19mm	Plástico	IP65	Para Interconectar 2 Mangueras
WAC-014	Kit de Conexión de Tubo LED	100W	90-260V~50/60Hz	-	-	-	170x21x14mm	Plástico	IP20	Para Tubo G13
WAC-015	Clip de Plástico para Fijación de Manguera	Máx. 100W	-	-	-	-	35x10x7mm	Plástico	IP65	Kit de 10 Piezas

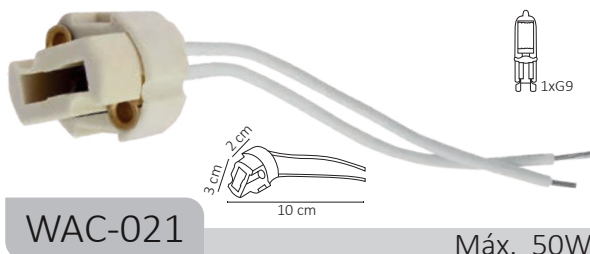

#	💡	Ⓜ	⚡	↔	💎	💧	🔍
Código	Producto	Watts	Voltaje	Dimensiones	Material	Protección	Observaciones
WAC-016	Atenuador RF para Manguera LED con Control	Máx. 500W	127V~50/60Hz	95x25x67mm	Aluminio	IP20	Med. Cable: 25.5cm y 16.6cm
WAC-017	Conector Medio para Manguera LED	Máx. 100W	127V~50/60Hz	16x59x10mm	Plástico + Pin de Metal	IP65	Incluye 2 Pines
WAC-018	Conector Simple para Manguera Neón	Máx. 300W	127V~50/60Hz	520x33mm	Plástico	IP65	Para Manguera Neón
WAC-019	Perfil de Aluminio Anodizado con Cubierta PC Opalina para Tira LED	-	-	2000x143x168mm	Aluminio + PC	IP20	Perfil para Tira LED
WAC-020	Kit de Instalación Perfil Aluminio para Tira LED	-	-	16.8x14.3mm	Lámina y Plástico	IP20	Accesorio para WAC-019 2 Tapones y 2 Grapas
WAC-021	Conector G9	Máx. 50W	90-260V~50/60Hz	100x20x30mm	Cerámica	IP20	Cable 14cm
WAC-022	Contratuercas Base E26	Máx. 50W	90-260V~50/60Hz	54x52mm	Plástico	IP20	Base E26



WAD-001

Máx. 50W



WAD-002

Máx. 50W



WAD-003

Máx. 50W



WAD-004

Máx. 50W

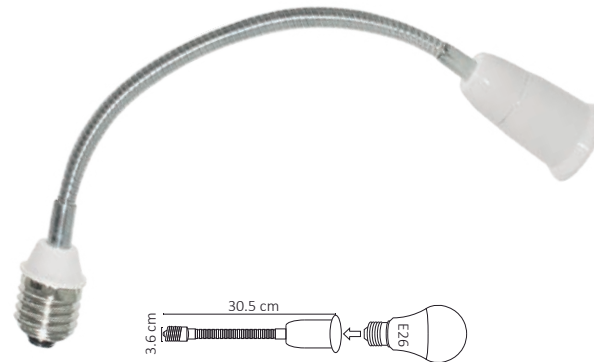

WAD-005

Máx. 50W



WAD-006

Máx. 50W

#	💡	W	⚡	☀️	360°	📏	💎	💧	🔍
Código	Producto	Watts	Voltaje	Lúmenes	Apertura	Dimensiones	Material	Protección	Observaciones
WAD-001	Adaptador de Base E26 a Lámpara E12	Max. 50W	90-300V~50/60Hz	-	-	29x26mm	Lámina + Plástico	IP20	E26 a E12
WAD-002	Adaptador de Base E26 a Lámpara GU10	Máx. 50W	90-300V~50/60Hz	-	-	35x50mm	Lámina + Cerámica	IP20	E26 a GU10
WAD-003	Adaptador de Base E40 a Lámpara E26	Máx. 50W	90-300V~50/60Hz	-	-	45x50mm	Lámina + Plástico	IP20	E40 a E26
WAD-004	Adaptador de Base GU10 a Lámpara MR16	Máx. 50W	90-300V~50/60Hz	-	-	23x21mm	Lámina + Cerámica	IP20	GU10 a MR16
WAD-005	Adaptador Extensión Flexible 30cm de Base E26 a Lámpara E26	Máx. 50W	90-300V~50/60Hz	-	-	305x36mm	Lámina + Plástico	IP20	Extensión 30cm E26 a E26
WAD-006	Adaptador de Base E14 a Lámpara E12	Máx. 50W	90-300V50/60Hz	-	-	18x27mm	Lámina + Plástico	IP20	E14 a E12

# CATÁLOGO 2023

i l u m i n a c i ó n l e d



**ar7lite**  
ILUMINACIÓN LED

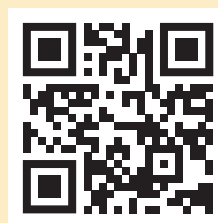

[www.innlite.com](http://www.innlite.com)



**WINLED**  
Más que Iluminación



NOM-058-SCFI-2017  
NOM-003-SCFI-2014  
NOM-030-ENER-2016  
NOM-031-ENER-2019

Grupo INNLITE, te informa que nuestros productos se encuentran certificados bajo la **NORMA OFICIAL MEXICANA**. Cada familia de producto, requiere una o varias NOM en específico, la cual **Grupo INNLITE**, puede brindarte a solicitud expresa.

¿Porque comprar productos certificados? El certificado de cada producto, garantiza que nuestros productos cumplen con los criterios de Calidad, Seguridad, Eficiencia y Correcto Funcionamiento, que demanda el gobierno federal, a través de sus dependencias competentes.

Cuando utilizas Producto **AR7LITE** o **WINLED**, estas garantizando la satisfacción de tu cliente o proyecto.